



THE MEASURABLE DIFFERENCE

Fyrite® Insight® Plus

CO Field Calibration

O₂ Sensor Replacement



Accessing the Sensors.....	4
Components.....	6
Sensor Calibration.....	8
Channel Calibration.....	10
Sensor Replacement.....	12
B-SMART [®] Sensors.....	18

Accessing the Sensor

Fyrite® Insight® Plus

Accessing the sensors

1. Remove magnetic boot (if so equipped).
2. Remove sensor cover by pushing latch up and lifting cover off instrument.
3. The O₂ (Oxygen) and CO (carbon Monoxide) sensor are exposed.

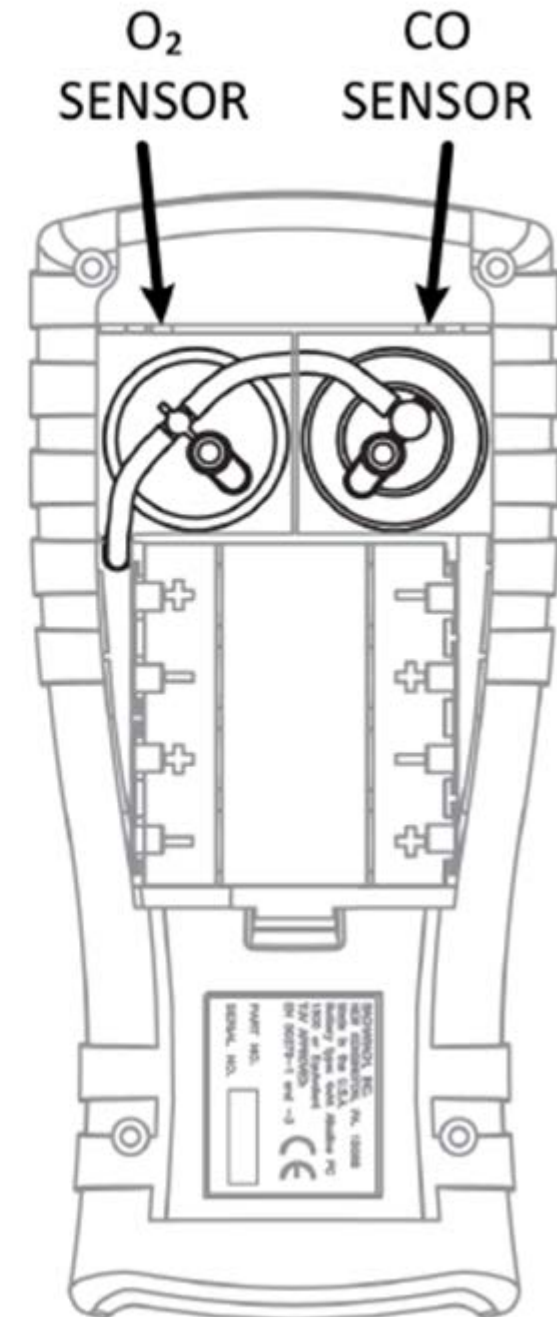
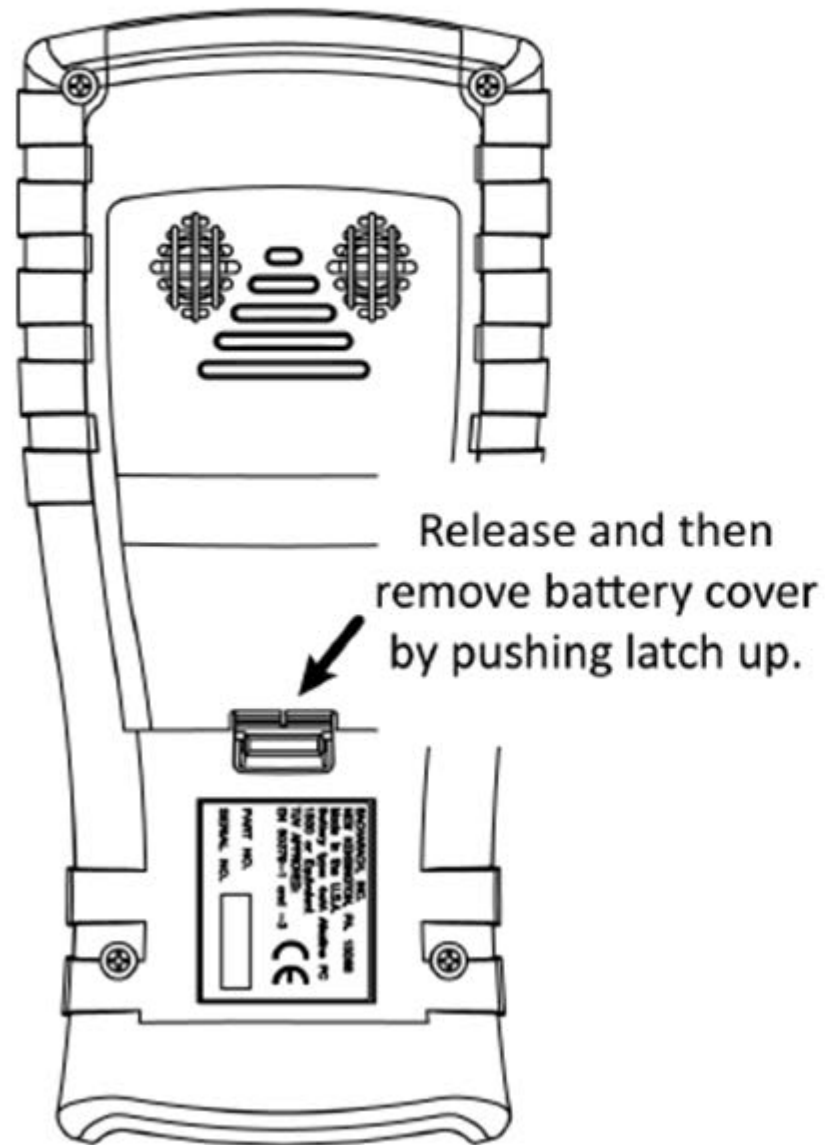

Components

Fyrite® Insight® Plus



Components needed to Calibrate existing CO sensor



- p/n 24-7059 Calibration Kit:**
- Regulator tubing assembly
 - Flow meter
 - Carrying case





- p/n 24-0492 Calibration Gas:**
- Carbon Monoxide
 - Gas Mixture 500 ppm CO
 - Background Gas Air
 - Cylinder Capacity 103L
 - Accuracy +/-2 Percent

Sensor Calibration





Fyrite® Insight® Plus

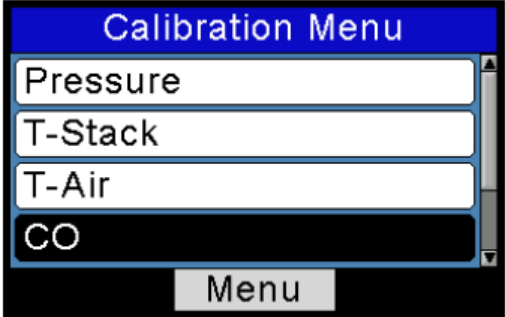

CO Sensor Calibration

From the Calibration Menu, in the Insight Plus analyzer use the UP  and DOWN  arrow keys to highlight CO, and then press ENTER to display the CALIBRATE CO screen. Note that this requires password validation 1111

See next slide for calibration kit set up and instructions.

Calibration Menu	Function
	<p>Calibration is performed by applying known values and accessing the password-protected menu items. When the Calibration Menu is selected, the user must enter a 4-digit numeric security code in order to proceed to the calibration options. The default password is 1111.</p> <p>Use the UP () and DOWN () arrow buttons to scroll through numerals 0-9 until the desired numeral is reached. Press ENTER to advance to the next position of the password. Press ENTER after all four digits are set. Press ESC to return to the SETUP MENU.</p> 
	<p>NOTE: The calibration password can be changed through the Fyrite User Software (FUS).</p>

Channel Calibration

Fyrite® Insight® Plus



CO Channel Calibration

- Enter into Calibration mode using Calibration password “1111”
- Select CO Calibration from menu
- Verify menu shows “Calibrate CO”
- Apply 500 ppm CO calibration gas using the excess flow method set to 1 LPM

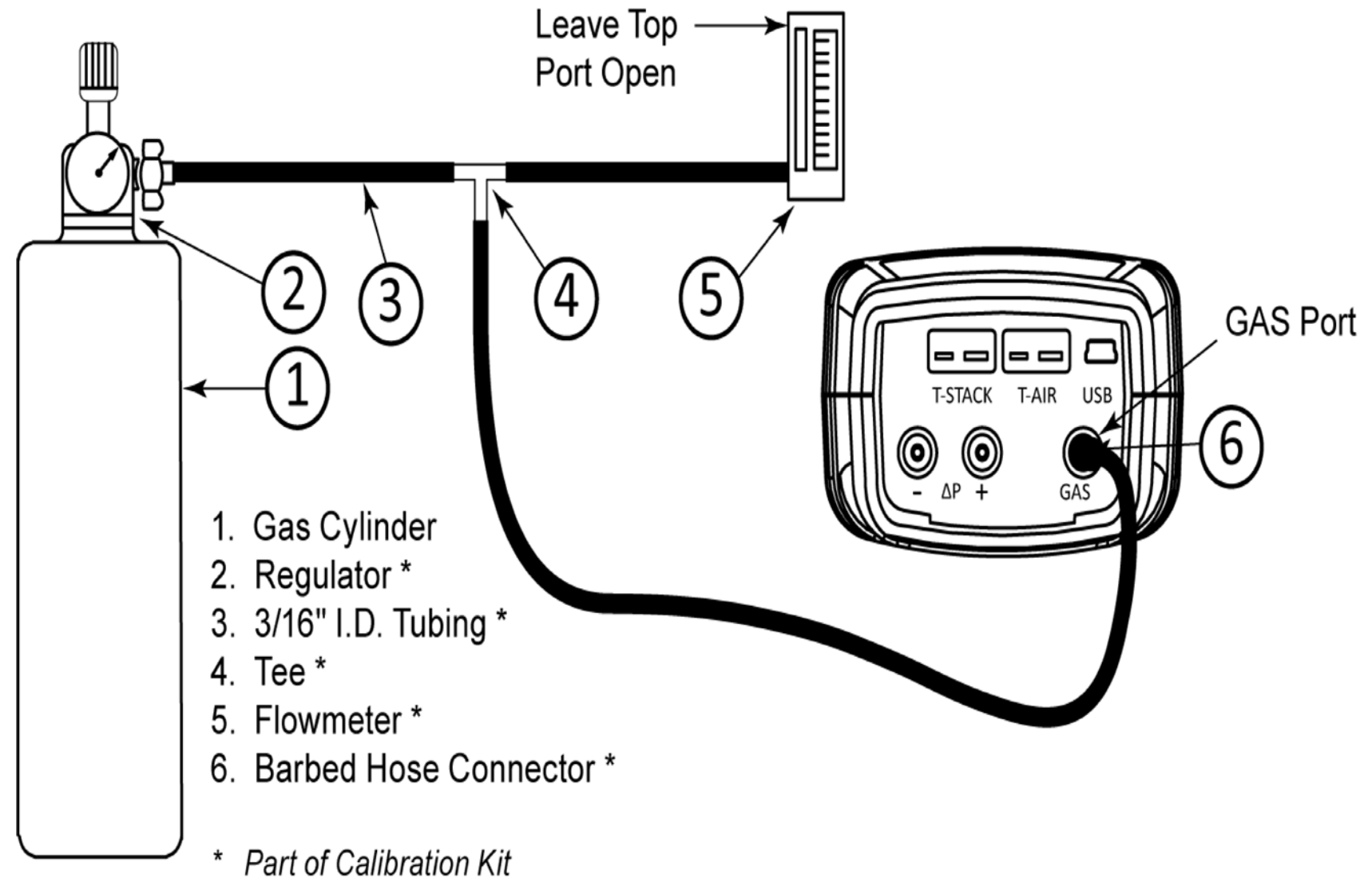



CO Channel Calibration

- After 3 minutes press ENTER on the Insight to calibrate the CO channel
- “Good Calibration” must briefly display then return to the Calibration List Menu

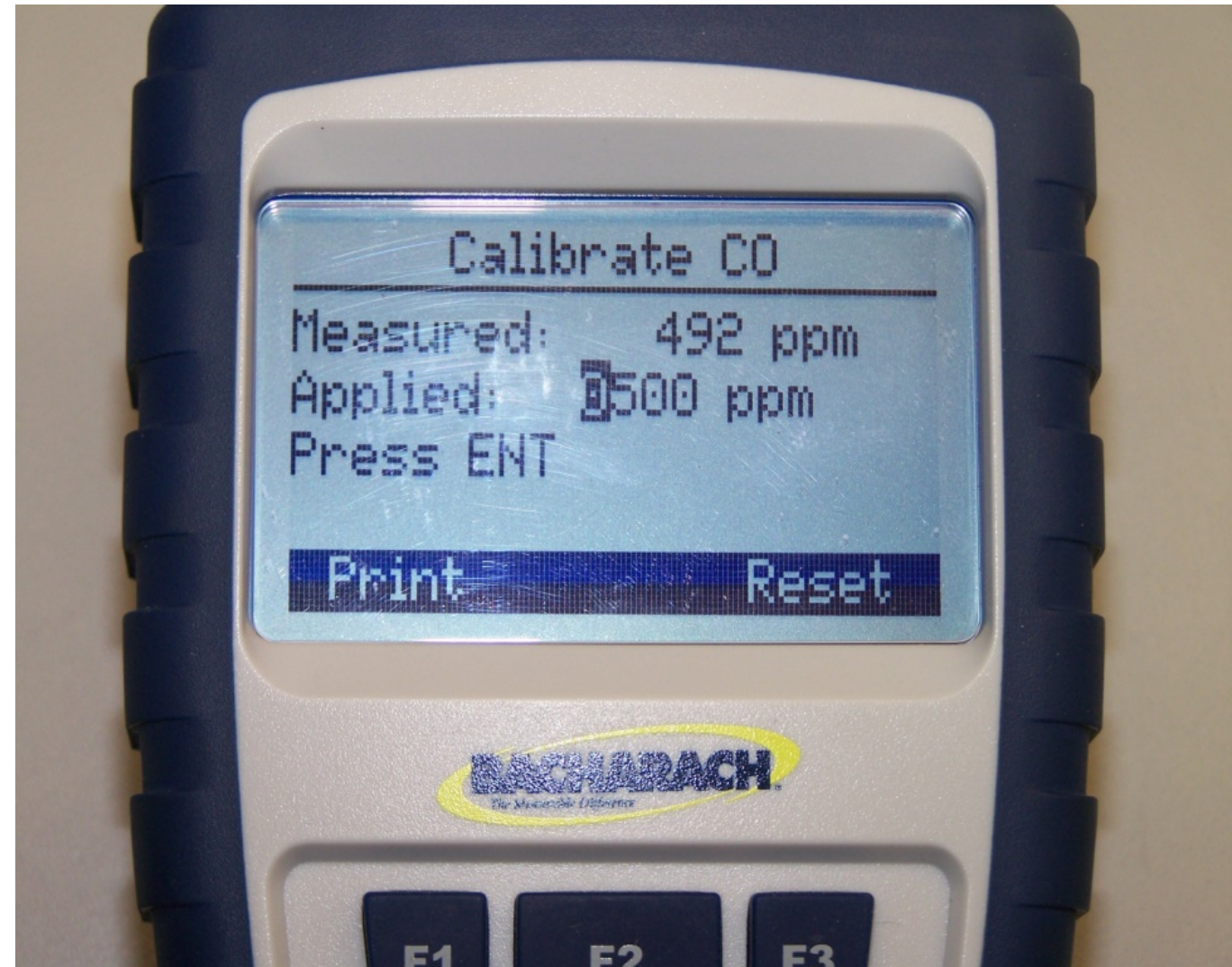

Sensor Replacement

Fyrite® Insight® Plus



O₂ Sensor Replacement



Oxygen Sensor
2 Years



Oxygen Sensor
3 Years



O₂ Sensor Replacement

Step	CO Sensor Replacement Procedure
1	Remove battery door and the connector tubing from the CO sensor.
2	Remove CO cap by twisting counter clockwise.
3	Gently pull CO sensor out of its socket.
4	Properly dispose of the old CO sensor.
5	Plug new CO sensor into its socket.
6	Install the CO cap by aligning it toward the "open" position (12 o'clock) as shown in the diagram below, then twisting the cap clockwise approximately 40° to the "closed" position (2 o'clock).
7	Reattach tubing.
8	Calibrate the CO sensor (using the calibration procedure on page 93, or using the B-SMART [®] procedure on page 85).

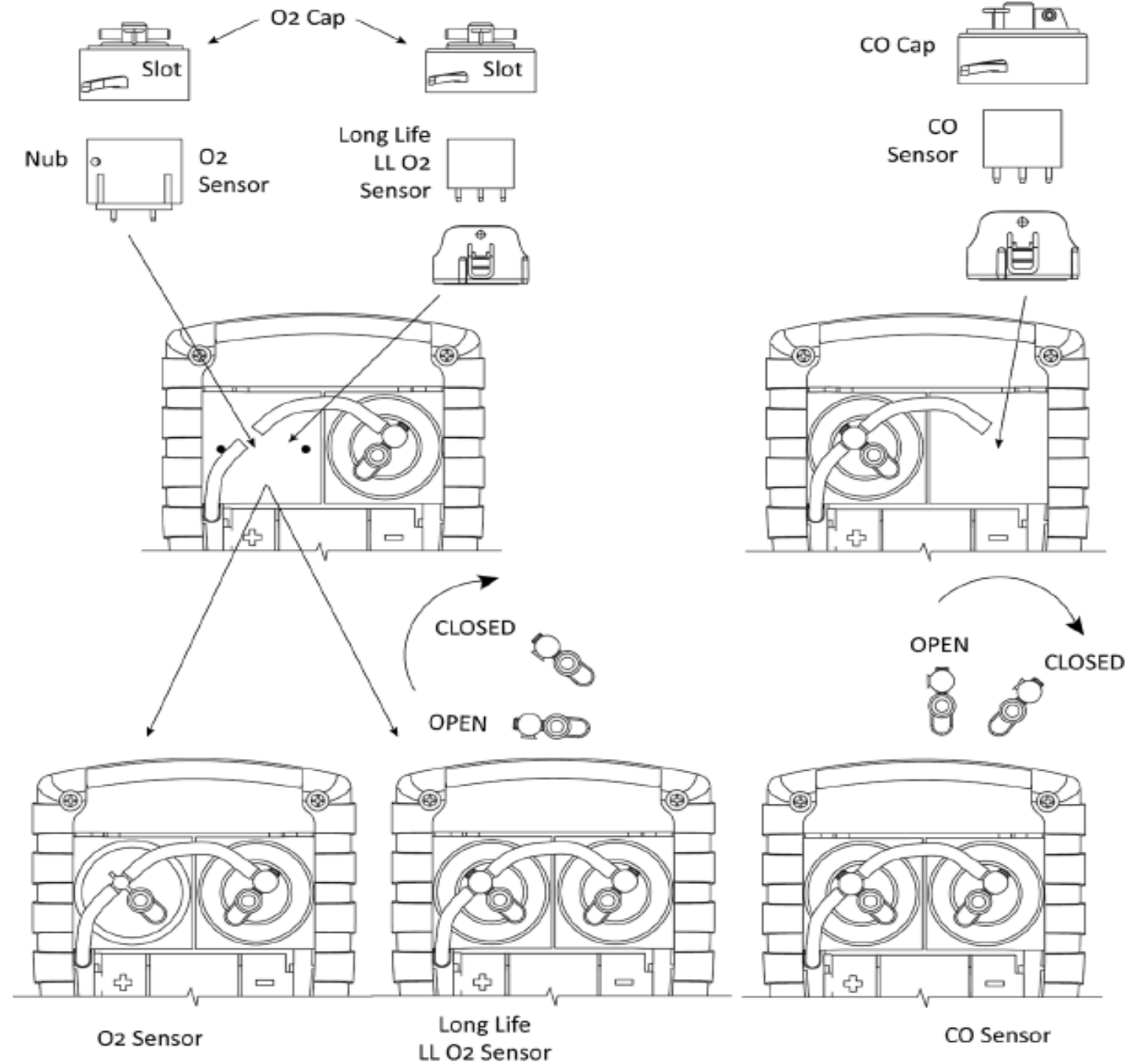

O₂ , LL O₂, and CO Sensor Replacement



O₂ Sensor Replacement

Function

When the O₂ life reaches the end of the graph segment, an error message is displayed (see below).

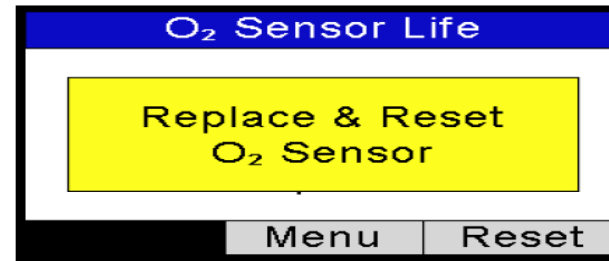

In this case:

- Note the 3-digit date code on the new sensor
- Replace the O₂ sensor
- Press F3 to change and verify sensor date code.

Resetting the Sensor Date Code

Use the LEFT (◀) and RIGHT (▶) arrow buttons to move the cursor horizontally to select between the 2-digit month code (00-12) and the one digit year code (0-9 corresponding to the last digit of the manufacture year) that make up the 3-digit date code.

Use UP (▲) and DOWN (▼) arrow buttons to increment and decrement the selected field's value. When finished, press ENTER to save the changes.

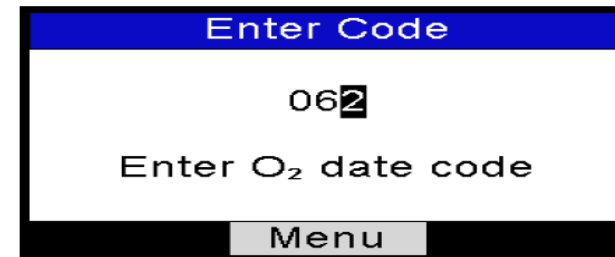

NOTE: Entering a value of 000 (three zeros) disables this feature.



O₂ Sensor Replacement Continued

Function

Next, verify the current month and year. Use the arrow keys to edit the current month and year (if needed) and press ENTER to confirm.

Set Clock

07/2012

Verify the month/year

Menu

Set Clock

07/2012

Verify the month/year

Menu

NOTE: Use this feature as a reminder only. This status is based on:

- the date code on the sensor (that you enter)
- the current date (that you enter)
- the typical O₂ life span (2 years)
- the output of the sensor



If either of the entered values is incorrect, the status of your O₂ sensor life will not be accurate. Actual sensor life may vary.

B-SMART[®] Sensors

Fyrite[®] Insight[®] Plus





CO B-SMART[®] Sensor Replacement



CO B-SMART[®] Sensor

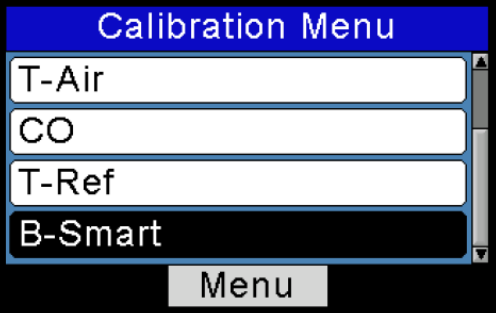
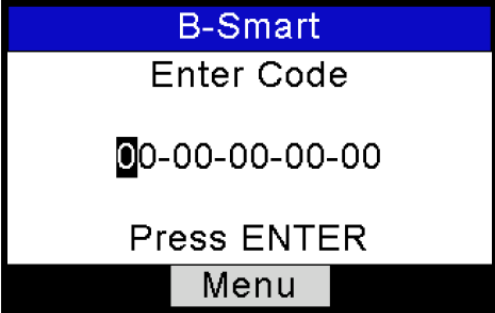

CO B-SMART[®] Sensor Replacement

Step	B-SMART [®] CO Sensor Replacement Procedure
1	Enter the CALIBRATION MENU. Note that this requires password validation Code 1111
2	Use the UP (▲) and DOWN (▼) arrow buttons to select B-Smart. Press ENTER to display the B-Smart code screen.
3	<p>Use the UP (▲) and DOWN (▼) arrow buttons to enter the 10-digit alphanumeric code supplied with the pre-calibrated B-SMART[®] sensor. Use the LEFT (◀) and RIGHT (▶) arrow buttons to move the cursor across the screen. Press ENTER.</p> <div data-bbox="1441 730 1937 1043"></div> <div data-bbox="1977 730 2473 1043"></div> <hr/> <p> NOTE: If the correct code was entered, the analyzer accepts it and returns to the CALIBRATION MENU. If an incorrect code was entered, the screen will display "Invalid Code." Check to make sure the correct code has been entered. If problem persists, contact your nearest Bacharach Service Provider.</p> <hr/> <p> NOTE: B-SMART[®] codes can be entered through the Fyrite[®] User Software (FUS).</p>

Thank you for your attention.



Bacharach Inc.
621 Hunt Valley Circle
New Kensington, PA 15068

Direct: 724-334-5000
Fax: 724-334-5001

mybacharach.com