



Rev. B | 2020.05

**LPT-B** BACnet® Digital Transmitter

---

## TABLE OF CONTENTS

<b>1 POLICIES</b> .....	<b>6</b>
1.1 Important Note .....	6
1.2 Warranty Policy .....	7
1.3 Service Policy .....	8
1.4 Copyrights .....	9
1.5 Disclaimer .....	9
1.6 Revisions .....	9
<b>2 INTRODUCTION</b> .....	<b>10</b>
2.1 General Description .....	10
2.2 Key Features .....	11
<b>3 INSTRUMENT SPECIFICATIONS</b> .....	<b>11</b>
3.1 Technical Specifications .....	11
3.2 Internal Sensor Gas Types .....	15
3.3 ESH-A Remote Sensor Gas Types .....	16
3.4 Enclosure Dimensions .....	17
<b>4 INSTRUMENT FEATURES</b> .....	<b>18</b>
4.1 Exterior Enclosure .....	18
4.2 Interior System Layout .....	20
<b>5 INSTALLATION</b> .....	<b>22</b>
5.1 Special Considerations for Different Types of Sensors .....	22
5.2 General Safety Warnings .....	23
5.3 Protection Against Electrical Risks .....	23
5.4 Protection Against Mechanical Risks .....	24

5.5 Mounting the Transmitter .....	25
5.5.1 Wet Environment Considerations .....	25
5.5.2 EMI and RF Interference Considerations .....	25
5.5.3 Mounting Height (Sensor Dependent) .....	26
5.6 Enclosure Mounting Components .....	27
5.6.1 Enclosure Base .....	27
5.6.2 Enclosure Bottom .....	28
5.7 Wiring Connections .....	28
5.7.1 Power & Output Connections .....	29
5.7.2 Relay Wiring Connection .....	30
5.7.3 ESH-A Remote Sensor Wiring Connection.....	31
5.7.4 BACnet® Wire Gauge vs Run Length .....	32
<b>6 SYSTEM OPERATION &amp; CONFIGURATION.....</b>	<b>32</b>
6.1 Navigating the Menu Structure.....	33
6.2 Accessing the Menu with Passcodes.....	34
6.3 Power Up and Warm-up.....	35
6.4 Display Select.....	36
6.5 Set LCD Display Contrast Level.....	37
6.6 Fault Detection.....	37
6.7 BACnet® Settings .....	38
6.7.1 Change BACnet® MAC ID .....	38
6.7.2 Change BACnet® Base ID .....	39
6.7.3 Change BACnet® Baud Rate.....	39
6.7.4 BACnet® Holding Registers.....	40
6.8 Alarm / Buzzer Operation.....	40
6.8.1 Enable / Disable Audible .....	41
6.8.2 Audible ON Delay .....	41

---

6.8.3 Audible Alarm Level Assignment.....	42
<b>6.9 Relay Operation .....</b>	<b>43</b>
6.9.1 Enable / Disable Relay.....	43
6.9.2 Setting Relay ON / OFF Delay.....	44
6.9.3 Relay Mode of Operation (Normal or FAILSAFE).....	45
6.9.4 Relay Alarm Level Assignment .....	45
<b>6.10 Test Functions .....</b>	<b>46</b>
6.10.1 Test Audible / Buzzer .....	46
6.10.2 Test Relay .....	47
6.10.3 Test Gas Reading Response / Send Test Reading to Controller.....	48
<b>6.11 Setting Channel Alarm Setpoints .....</b>	<b>49</b>
6.11.1 LOW Alarm Setpoint.....	49
6.11.2 MID Alarm Setpoint.....	50
6.11.3 HIGH Alarm Setpoint.....	51
6.11.4 Setting Hysteresis.....	51
6.12 Enable / Disable Channels.....	52
<b>7 CALIBRATION.....</b>	<b>52</b>
7.1 Calibration Specifications.....	52
7.1.1 Gas.....	52
7.1.2 Regulators & Flow.....	53
7.1.3 Adapters.....	53
7.1.4 Calibration Frequency .....	53
7.1.5 Gas Testing Frequency (Bump Testing) .....	54
7.1.6 Sticky Gases.....	54
7.1.7 Non-Intrusive Calibration.....	54
7.2 Calibrating the Internal Sensor(s) .....	55
7.3 Troubleshooting Calibration .....	57

---

---

7.3.1 Calibration Adapter Plug .....	57
7.3.2 Zero Calibration Shift.....	58
7.3.3 Zero - Requires Override .....	58
7.3.4 Span - Requires Override .....	58
7.3.5 Fault Reading .....	59
7.3.6 Calibration Failure .....	59
7.4 Calibrating an ESH-A Remote Sensor Connected to an LPT-B .....	59
7.4.1 Zero and Span Calibration of a Responsive ESH-A Remote Sensor .....	59
7.4.2 Zero Calibration of a New or Replacement ESH-A Remote Sensor.....	60
7.5 Calibrating an Oxygen Sensor .....	61
<b>8 ACCESSORIES .....</b>	<b>63</b>
8.1 Splash Guard (Option -S).....	63
8.2 Calibration Adapter Clip "Cal Clip" .....	63
8.3 Magnetic Wand.....	64
8.4 Metal Protective Guard .....	64
8.5 Calibration Kit .....	65
<b>9 MAINTENANCE.....</b>	<b>66</b>
<b>10 TROUBLE SHOOTING .....</b>	<b>67</b>

# 1 POLICIES

## 1.1 Important Note

Read and understand this manual prior to using this instrument. Carefully read the warranty policy, service policy, notices, disclaimers and revisions on the following pages.

This product must be installed by a qualified electrician or factory trained technician and according to instructions indicated in this manual. This instrument should be inspected and calibrated regularly by a qualified and trained technician. For more information, refer to Section 7 *Calibration* and Section 9 *Maintenance* of this manual.

This instrument has not been designed to be intrinsically safe. For your safety, **do not** use it in classified hazardous areas (explosion-rated environments).

**INSTRUMENT SERIAL NUMBER:**

---

**PURCHASE DATE:**

---

**PURCHASED FROM:**

---

## 1.2 Warranty Policy

Critical Environment Technologies Canada Inc. warrants the products we manufacture (excluding sensors, battery packs, batteries, pumps, and filters) to be free from defects in materials and workmanship for a period of two years from the date of purchase from our facility. As a reminder, sensors are consumable items and once they leave our factory, we cannot reuse or resell them. As such, all sensor sales are final. Should the sensor itself be faulty, there is a one-year pro-rated warranty that would apply from the date of purchase from our facility.

The warranty status may be affected if the instrument has not been used and maintained as per the instructions in the manual or has been abused, damaged, or modified in any way. The product is only to be used for the purposes stated in the manual. Critical Environment Technologies is not liable for auxiliary interfaced equipment or consequential damage.

All returned goods must be pre-authorized by obtaining a Returned Merchandise Authorization (RMA) number. All goods must be shipped to Critical Environment Technologies freight prepaid. Contact the manufacturer for an RMA number and procedures required for product transport.

Due to ongoing research, development, and product testing, the manufacturer reserves the right to change specifications without notice. The information contained herein is based on data considered accurate. However, no warranty is expressed or implied regarding the accuracy of this data.

## 1.3 Service Policy

CETCI maintains an instrument service facility at the factory. Some CETCI distributors / agents may also have repair facilities; however, CETCI assumes no liability for service performed by anyone other than CETCI personnel.

Repairs are warranted for 90 days after date of shipment (sensors have individual warranties). Should your instrument require non-warranty repair, you may contact the distributor from whom it was purchased or you may contact CETCI directly.

Prior to shipping equipment to CETCI, contact our office for an RMA #. All returned goods must be accompanied with an RMA number.

If CETCI is to do the repair work, you may send the instrument, prepaid, to:

**Attention: Service Department**  
**Critical Environment Technologies Canada Inc.**  
**Unit 145, 7391 Vantage Way**  
**Delta, BC, V4G 1M3**

You must include your Returned Merchandise Authorization (RMA) number, address, telephone number, contact name, shipping / billing information, and a description of the defect as you perceive it. You will be contacted with a cost estimate for expected repairs, prior to the performance of any service work. Pack the equipment well (in its original packing if possible), as we cannot be held responsible for any damage incurred during shipping to our facility. All incurred shipping charges, duties and taxes are your responsibility.

For liability reasons, CETCI has a policy of performing all needed repairs to restore the instrument to full operating condition.

## 1.4 Copyrights

This manual is subject to copyright protection; all rights are reserved. Under international and domestic copyright laws, this manual may not be copied or translated, in whole or in part, in any manner or format, without the written permission of CETCI.

BACnet® is a registered trademark of American Society of Heating, Refrigeration and Air Conditioning (ASHRAE).



## 1.5 Disclaimer

Under no circumstances will CETCI be liable for any claims, losses or damages resulting from or arising out of the repair or modification of this equipment by a party other than CETCI service technicians, or by operation or use of the equipment other than in accordance with the printed instructions contained within this manual or if the equipment has been improperly maintained or subjected to neglect or accident. Any of the forgoing will void the warranty.

Under most local electrical codes, low voltage wires cannot be run within the same conduit as line voltage wires. It is CETCI policy that all wiring of our products meet this requirement.

It is CETCI policy that all wiring be within properly grounded (earth or safety) conduit.

## 1.6 Revisions

This manual was written and published by CETCI. The manufacturer makes no warranty or representation, expressed or implied including any warranty of merchantability or fitness for purpose, with respect to this manual.

All information contained in this manual is believed to be true and accurate at the time of printing. However, as part of its continuing efforts to improve its products and their documentation, the manufacturer reserves the right to make changes at any time without notice. In addition, due to improvements made to our products, there may be information in this manual that does not exist in the version of the product the user has. Should you detect any error or omission in this manual, or should you want to inquire regarding upgrading the device's firmware, please contact CETCI at the following address:

### **Critical Environment Technologies Canada Inc.**

Unit 145, 7391 Vantage Way, Delta, BC, V4G 1M3, Canada

Toll Free: +1.877.940.8741

Telephone: +1.604.940.8741  
Fax: +1.604.940.8745  
Email: [marketing@cetci.com](mailto:marketing@cetci.com)  
Website: [www.critical-environment.com](http://www.critical-environment.com)

In no event will CETCI, its officers or employees be liable for any direct, special, incidental or consequential damages resulting from any defect in any manual, even if advised of the possibility of such damages.

## 2 INTRODUCTION

### 2.1 General Description

Thank you for purchasing our LPT-B BACnet® Transmitter. The LPT-B is a full-featured, digital gas detector for monitoring toxic and combustible gases in non-hazardous (non-explosion rated) environments such as commercial HVAC and light industrial applications. It is designed to communicate with a controller or building automation system (BAS) with BACnet® MS/TP communication.

Sensor configuration options include one, two or three channel operation with a comprehensive choice of sensors for many toxic gases (electrochemical) and combustible (catalytic) gases, plus PID TVOCs. All LPT-B transmitters operate by diffusion. The sensors utilized in this device are accurate enough to measure to Occupational Health & Safety (OHS) hazardous levels for toxic gases.

Operating as a digital transmitter the LPT-B offers an audible internal alarm, one dry contact relay, graphic LCD display with user selectable functions, temperature compensation and an automatic thermal resetting fuse all in a RoHS compliant package and standard water / dust tight enclosure. With the optional splash guard installed, the enclosure is IP54 rated and will be protected in water spray or wash down applications. If after reading through the manual, you have any questions, please do not hesitate to contact our Technical Service Department for technical support.

---

## 2.2 Key Features

- Up to 3 sensor configurations: single or dual internal electrochemical sensor and/or one remote catalytic combustibile or PID TVOC sensor
- BACnet® MS/TP communication
- Graphic LCD display (user selectable function)
- Internal audible alarm
- 1 dry contact relay, 30 volt, 2 amp maximum
- 4-conductor shielded network wiring (daisy-chain)
- 24 volt DC or AC power (ground referenced)
- Standard water / dust tight, corrosion resistant enclosure (drip proof). With optional splash guard installed, the enclosure is IP54 rated.
- RoHS compliant circuit boards
- Auto resetting fuses

## 3 INSTRUMENT SPECIFICATIONS

### 3.1 Technical Specifications

#### MECHANICAL

Enclosure	ABS / Polycarbonate, IP54 rating with splash guard installed. Copper coated interior to reduce RF interference.
Weight	400 g / 14 oz
Size	127 mm x 127 mm x 71 mm 5.0 in x 5.0 in x 2.8 in

---

## ELECTRICAL

---

Power Requirement	16 - 30 VDC, 3 W, Class 2 12 - 27 VAC, 50-60 Hz, 3 VA, Class 2 24V recommended. Refer to Section 5.7 <i>Wiring Connections</i>
Current Draw	55 mA (buzzer & relay energized, 2 sensors)
Wiring (4-wire)	VDC or VAC (ground referenced) four-conductor shielded 16 AWG stranded within conduit, network wiring (daisy-chain)
Fuses	Automatic resetting thermal

---

## USER INTERFACE

---

Display	Graphic LCD. Text prompting for calibration operation and fault indications. Installer configurable to suppress all other displays.
Magnetic Sensors	Use a magnetic wand to initiate calibration and access menu functions without opening the enclosure
Audible Alarm	Standard internal buzzer, rated 90 dB @ 10 cm, enable/disable

---

---

**INPUT/OUTPUT**

---

Communication	BACnet® MS/TP; ANSI/ASHRAE standard 135 BACnet® Communication protocol: 135-2012 Baud Rate: 76,800 (default) Base Address: 270 (default) MAC Address: 100 (default) Parity: no parity Stop bits: 1 Data bits: 8
Relay	One SPDT dry contact relay, 30V, 2A maximum

---

**ENVIRONMENTAL**

---

Operating Temperature	-20°C to 40°C / -4°F to 104°F
Operating Humidity	15 - 90% RH non-condensing

---

## CERTIFICATION

---

Model: LPT-B-XXX

S/N: LPTB1603B00001

Rating: 16-30 VDC, 3W, Class 2

12-27 VAC, 50-60 Hz, 3VA, Class 2

CERTIFIED FOR ELECTRIC SHOCK & ELECTRICAL FIRE HAZARD ONLY. LA CERTIFICATION ACNOR COUVRE UNIQUEMENT LES RISQUES DE CHOC ELECTRIQUE ET D'INCENDIE D'ORIGINE ELECTRIQUE.

Conforms to: CSA-C22.2 No. 205-12 / UL508 (Edition 17):2007

Conforms to: EMC Directive 2004/108/EC, EN 50270:2006, Type 1, EN61010

Conforms to: FCC. This device complies with part 15 of the FCC Rules, Operation is subject to the following two conditions: (1) This device may not cause harmful interference, and (2) this device must accept any interference received, including interference that may cause undesired operation.



## 3.2 Internal Sensor Gas Types

Internal Electrochemical Sensors	Part Number	Range	Lifespan
Ammonia (NH <sub>3</sub> )	LPT-B-NH3	0 - 500 ppm	~2 years
Carbon Monoxide (CO)	LPT-B-TCO	0 - 200 ppm	~6 years
Chlorine (Cl <sub>2</sub> )	LPT-B-CL2	0 - 5.0 ppm	~3 years
Chlorine Dioxide (ClO <sub>2</sub> )	LPT-B-ClO2	0 - 1.0 ppm	~2 years
Ethylene (C <sub>2</sub> H <sub>4</sub> )	LPT-B-C2H4	0 - 200 ppm	~2 years
Ethylene Oxide (C <sub>2</sub> H <sub>4</sub> O)	LPT-B-EETO	0 - 20 ppm	~2 years
Fluorine (F <sub>2</sub> )	LPT-B-F2	0 - 1.0 ppm	~1 - 2 years
Formaldehyde (CH <sub>2</sub> O)	LPT-B-CH2O	0 - 5.0 ppm	~2 years
Hydrogen (H <sub>2</sub> )	LPT-B-EH2	0 - 2,000 ppm	~2 years
Hydrogen Chloride (HCl)	LPT-B-HCL	0 - 30 ppm	~2 years
Hydrogen Cyanide (HCN)	LPT-B-HCN	0 - 30 ppm	~2 years
Hydrogen Fluoride (HF)	LPT-B-HF	0 - 10 ppm	~1 - 2 years
Hydrogen Sulphide (H <sub>2</sub> S)	LPT-B-H2S	0 - 50 ppm	~2 years
Hydrogen Sulphide (H <sub>2</sub> S)	LPT-B-H2SB	0 - 50 ppm	~5 years
Nitric Oxide (NO)	LPT-B-NO	0 - 100 ppm	~2 years

<b>Internal Electrochemical Sensors continued...</b>	<b>Part Number</b>	<b>Range</b>	<b>Lifespan</b>
Nitrogen Dioxide (NO <sub>2</sub> )	LPT-B-NO2A	0 - 10 ppm	~3 years
Nitrogen Dioxide (NO <sub>2</sub> )	LPT-B-NO2B	0 - 10 ppm	~6 years
Oxygen (O <sub>2</sub> )	LPT-B-O2	0 - 25% Vol	~3 years
Ozone (O <sub>3</sub> )	LPT-B-O3	0 - 1.0 ppm	~2 years
Phosphine (PH <sub>3</sub> )	LPT-B-PH3	0 - 5.0 ppm	~2 years
Silane (SiH <sub>4</sub> )	LPT-B-SIH4	0 - 20 ppm	~2 years
Sulphur Dioxide (SO <sub>2</sub> )	LPT-B-SO2	0 - 20 ppm	~2 years

### 3.3 ESH-A Remote Sensor Gas Types

#### ESH-A Remote Sensors - Combustible (Catalytic)

Hydrogen (H <sub>2</sub> )	ESH-A-CH2-100	0 - 100% LEL	~5 years
Methane (CH <sub>4</sub> )	ESH-A-CCH4-100	0 - 100% LEL	~5 years
Propane (C <sub>3</sub> H <sub>8</sub> )	ESH-A-CC3H8-100	0 - 100% LEL	~5 years

#### ESH-A Remote Sensors - PID TVOC

PID TVOC	ESH-A-SPL	0 - 30 ppm	usage / application dependent
	ESH-A-SPH	0 - 300 ppm	



### 3.4 Enclosure Dimensions

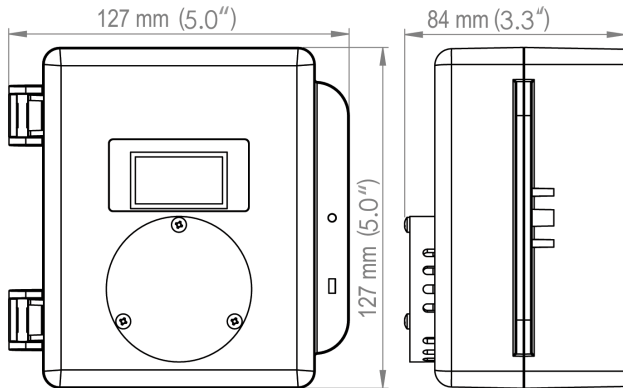

Above dimensions are shown with optional splash guard. Without splash guard, thickness is 71 mm / 2.8 in. The area required for enclosure door to be open 90 degrees is 178 mm / 7.0 in or 254 mm / 10.0 in for fully open. With the optional splash guard installed, the enclosure is IP54 rated.

**NOTE:** During calibration, the sensor response time will be slower with a splash guard installed.

**NOTE:** Splash guard is not available for transmitters with internal electrochemical Ozone ( $O_3$ ), Hydrogen Chloride (HCL) or Chlorine ( $Cl_2$ ) sensors.

## 4 INSTRUMENT FEATURES

### 4.1 Exterior Enclosure

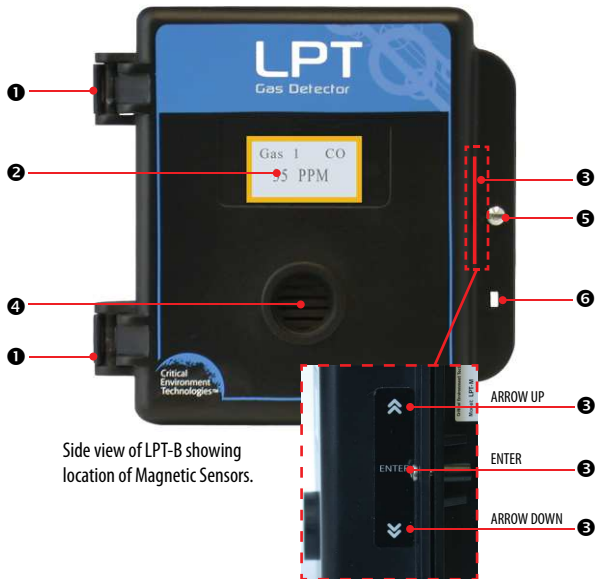

<b>NUMBER</b>	<b>FEATURE</b>	<b>FUNCTION</b>
<b>1</b>	Door Hinge	Secures door to base and allows easy opening and closing
<b>2</b>	Display with yellow border	Graphic LCD display. Yellow border indicates transmitter operation is BACnet®
<b>3</b>	Magnetic Sensors (arrow up, Enter, arrow down)	Use a magnetic wand to access menu options and program functions without opening the enclosure
<b>4</b>	Sensor Opening	Allows gas diffusion into sensor
<b>5</b>	Door Screw	Secures door shut
<b>6</b>	Padlock Opening	For security padlock

## 4.2 Interior System Layout

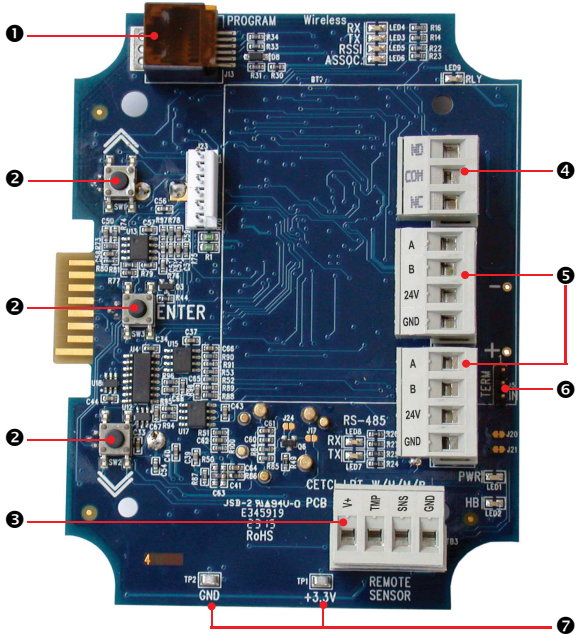

<b>NUMBER</b>	<b>FEATURE</b>	<b>FUNCTION</b>
①	RJ14 Programming Connection	Factory use only.
②	Programming Buttons	Access menu options and program functions using buttons inside the enclosure. (Arrow up, Enter, Arrow down)
③	Remote Sensor Terminal	Terminal for connecting the ESH-A Remote Sensor
④	Relay Terminal	Low voltage pluggable terminal for relay connection. 30 volts, 2 amps max
⑤	RS-485 Communication Terminals	Pluggable power and signal terminal for connection to controller and next transmitter.
⑥	Termination Resistor	Network termination resistor. "IN" position includes 120 ohm resistor.
⑦	TP1 and TP2	Test Points 1 and 2 to confirm voltage registers are working. Reading should be 3.3 volts.

## 5 INSTALLATION

The sensor in the LPT-B goes through a burn in period at our factory prior to shipping so it is ready for operation upon arrival. If you install the LPT-B when it arrives, most sensors will not require a long warm up period (about 5 minutes for Ammonia and Nitrogen dioxide, 2 minutes for the other gases, except Oxygen which is a minimum of 2 hours). If the device is not installed within two weeks of delivery, the sensor may require a longer warm up time to stabilize (approximately 48 hours) and provide accurate readings.

**NOTE: CETCI suggests that upon power-up, all sensors be left to warm up for 24 hours prior to considering the gas readings to be accurate.**

**NOTE: All sensors are calibrated in the factory and do not require calibration at the time of a routine installation.**

**NOTE:** Temperature affects calibration. It is important to ensure the gas is at the appropriate temperature during calibration. If the sensor is being used in an extreme temperature range, calibration should be done in that same temperature range.

### 5.1 Special Considerations for Different Types of Sensors

After installing an LPT-B with an Oxygen sensor, leave it to warm up for at least 2 hours before looking at the readings. If after at least 2 hours, the gas reading is not 20.9%, you should do a respan by following Step 1 in Section 7.5 *Calibrating an Oxygen Sensor*.

After a substantial warm up period, an Ethylene Oxide sensor should be zeroed on site if the ambient temperature is above 22°C (71.6°F). This particular sensor has a drift factor that can be as much as 1 ppm if the temperature rises to 25°C (77°F). With the low set point you could experience false alarms.

During calibration, when flowing span gas on an Ammonia sensor, if the reading climbs higher than the calibration point after applying gas for 3 minutes, use that reading as the calibration point. It should be around 300 ppm.

Ozone sensors are reactive to temperature changes and will drift.

Silicone, lead and chlorinated hydrocarbon vapours can poison catalytic sensors.

A bump test will help you determine if a sensor requires calibration. If the sensor still does not respond as it should after a successful calibration, it probably requires replacing.

## 5.2 General Safety Warnings

The LPT-B is intended for indoor use, permanently mounted at a height that is appropriate for the type of gas being monitored. Refer to Section *5.5 Mounting the Transmitter*. The LPT-B should be protected from extreme weather conditions.

The LPT-B requires no assembly and virtually no maintenance other than regular calibration of the internal and/or remote sensors and ensuring that excess water or dust is not somehow entering the enclosure and physically damaging the circuit board or internal components. There are no serviceable elements other than the calibration instructions outlined in this manual. There are no replaceable components except the sensors.

## 5.3 Protection Against Electrical Risks

Disconnect all power before servicing. There may be multiple power sources. Power supply may have a building installed circuit breaker / switch that is suitably located and easy to access when servicing is required and should be labelled as LPT-B supply (disconnecting power to the LPT-B). Appropriate markings should be visible at the circuit breaker / switch that is supplying power to the LPT-B.

This device may interfere with pacemakers. Modern pacemakers have built-in features to protect them from most types of interference produced by other electrical devices you might encounter in your daily routine. If you have a pacemaker, follow your healthcare provider's instructions about being around this type of equipment.

## 5.4 Protection Against Mechanical Risks

The door of the enclosure can be removed if absolutely necessary to facilitate installation of the base but it is not recommended on this version. Extreme care and caution must be exercised when removing the door to avoid damaging the hinges. The door should only be removed when absolutely required. Any damage occurring from door removal procedure will not be covered under warranty.

Grasp the door with one hand, being careful not to make contact with any of the internal components (circuit board), and grasp the base with your other hand. Tug on the base and pull straight apart. **DO NOT TWIST.** The section of the hinges located on the base should “snap” apart from the part of the hinges located on the door.

After installation, simply locate the lid hinges over the installed base hinges and pull toward you. The hinges should easily “snap” back into place.

The enclosure has one screw securing the door to the base for electrical safety and provides an opening to allow the user to apply a padlock or tie wrap if they desire the transmitter to be locked. Refer to Section 4.1 *Exterior Enclosure*.

Be aware that the hinged door that could potentially pinch fingers and the sharp edges and/or jumper pins on the board could potentially prick or cut fingers if not handled carefully.



## 5.5 Mounting the Transmitter

The LPT-B should be mounted on a flat vertical surface using the four 4.4 mm / 0.175 in diameter mounting holes provided to maintain water tight status. Care should be taken to ensure that the face of the LPT-B is not obstructed in order to maximize the sensor's exposure to the environment being monitored.

Two 12.7 mm / ½ in conduit entry points are provided in the enclosure. Both are located in the enclosure base. One in the rear of the base and one on the bottom edge of the base. Refer to Section 5.6 *Enclosure Mounting Components*.

The clearance from the PCA to the base enclosure is 12.7 mm / ½ in. **Do not use a conduit connector that has more than 12.7 mm (½ in) of thread length.**

**NOTE:** When mounting the enclosure, allow enough room to allow the end user to open the door fully to access the internal adjustments.

### 5.5.1 Wet Environment Considerations

If the LPT-B is to be installed in a potential hose-down application or any application whereby liquid could be directed towards the sensor opening, the LPT-B should be ordered with an optional attached splash guard (factory installed).

**If used in a wet or wash down application, the conduit hub entering the LPT-B enclosure must be liquid tight type.** Any water or physical damage to the transmitter that occurs from the installer drilling their own installation holes will not be covered under warranty.

### 5.5.2 EMI and RF Interference Considerations

All electronic devices are susceptible to EMI (Electromagnetic Interference) and RFI (Radio Frequency Interference). Our detectors have been designed to reduce the effects of these interferences and we meet CSA FCC and CE requirements for these type of devices. However, there

are still circumstances and levels of interference that may cause our equipment to respond to these interferences and cause them to react as if there has been gas detected.

There are some installation procedures that will reduce the likelihood of getting faulty readings:

1. Locate the detectors and controllers out of the way from normal foot traffic and high energy equipment.
2. Confirm the devices are properly grounded using conduit and shielded cabling.
3. Inform operators and technical staff working in the surrounding area to be aware of these possible conditions and that two way radios, Bluetooth enabled devices, cell phones and other electrical equipment may interfere with the response of the gas detectors.

### 5.5.3 Mounting Height (Sensor Dependent)

The sensor mounting height depends on the density of the gas relative to air. Heavier than air gases should be detected 6 in / 15 cm from the floor, lighter than air gas sensors should be placed on or near the ceiling, and gases which have a density close to that of air should have sensors installed in the “breathing zone” 4 - 6 f / 1.2 - 1.8 m from the floor. The breathing zone refers to the area 4 - 6 ft / 1.2 - 1.8 m from the floor, where most human breathing takes place. This is a good default location for sensors, as many gases are often well dispersed in air.

<b>GAS</b>	<b>APPLICATIONS / TYPES</b>	<b>SUGGESTED MOUNTING HEIGHT</b>
Carbon Monoxide (CO)	Gas engine exhaust	1.2 - 1.8 m above the floor
Nitrogen Dioxide (NO <sub>2</sub> )	Diesel engine exhaust	4 - 6 ft above the floor
Ammonia (NH <sub>3</sub> )	Commercial ice rinks Compressor rooms	Near the ceiling

Chlorine (Cl<sub>2</sub>)

Commercial swimming pools

15 cm above the floor

Ozone (O<sub>3</sub>)

6 in above the floor

## 5.6 Enclosure Mounting Components

### 5.6.1 Enclosure Base

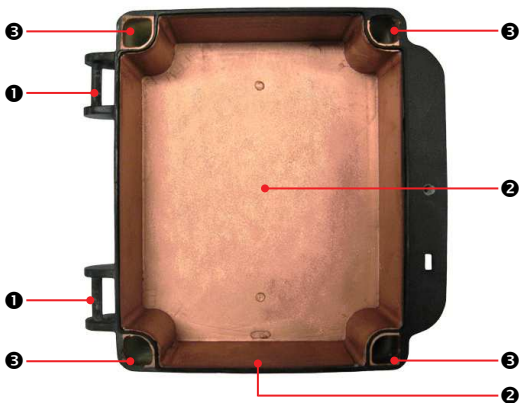

#### NUMBER

#### FEATURE

①

Door Hinge

②

1/2" Conduit Entry Knockout

③

Mounting Holes

## 5.6.2 Enclosure Bottom



NUMBER	FEATURE
1	Door Hinge
2	1/2" Conduit Entry Knockout

## 5.7 Wiring Connections

The LPT-B digital transmitter is a low voltage powered device. Any application of operating voltages higher than indicated in the specification may result in damage. Double check wiring connections prior to powering the transmitter. Damage from incorrect wiring connections or from too much voltage applied is not covered under warranty.

All wiring should be run in EMT (or better) conduit properly earth grounded. All communications (network) wiring must be in shielded cabling. The shield should be connected to earth ground close to the primary supply connection only, and must have a contiguous connection throughout the network. Communication uses a daisy chain configuration. The recommended 4 conductor, 16 AWG, shielded stranded wire cable types are AlphaWire 79220, Belden 9954 or equivalent.

### **NOTE: WARRANTY VOID IF SOLID-CORE WIRE IS USED AT THE WIRING TERMINAL STRIP.**

When using solid core wiring for distribution (in the conduit), use stranded wire pigtailed 18 AWG

within the enclosure to connect to the circuit board. The rigidity of solid-core wire can pull a soldered terminal strip completely off a circuit board and this will not be covered under warranty.

### 5.7.1 Power & Output Connections

This device must be used with rated equipment. External power to the LPT-B must be supplied by a 24 VDC power supply or a VAC Class 2 Transformer needs to be used. In all cases the voltage supply to the LPT-B should never drop below 18 VDC or 20 VAC.

**System power:** The main wiring terminal strip on the LPT-B circuit board can be unplugged for easier wiring installation. Grasp the two sides of the terminal strip and pull sideways.

The wiring should be 4-conductor shielded 16 awg stranded within conduit in a network wiring (daisy-chain) configuration.

#### Wiring Example: 4-Wire VAC

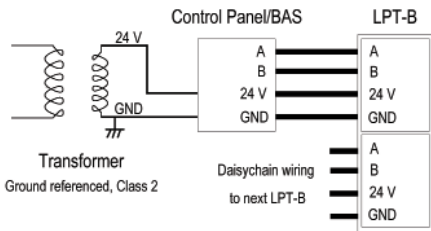

## Wiring Example: 4-Wire VDC

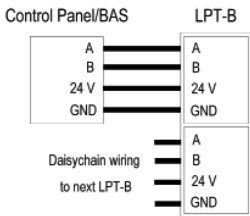

### 5.7.2 Relay Wiring Connection

The relay operates in "failsafe" mode, i.e. the relay coil is energized under normal non-alarm conditions. The relay is de-energized when if power fails.

In most applications the relay function should use the common "COM" and normally closed "NC" terminals. With this wiring the connection will be open under normal, low gas concentration conditions. When the gas concentration rises to the configured alarm point or if there is a power failure the connection relay will close.

## Wiring Example: Relay

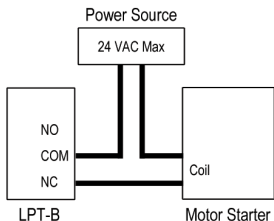

### 5.7.3 ESH-A Remote Sensor Wiring Connection

*Each ESH-A is given the same serial number as the device it is being connected to. Make sure to connect the ESH-A to the LPT-B that has the same serial number or the system won't work.*

Four-conductor, 16 AWG stranded shielded cable is required for the remote sensor wiring. This wiring should be run in a conduit, separate from the signal output, and should not exceed 61 m (200 ft). The voltage at the remote sensor (Red V+ to Black GND) should be 24 VDC. If this voltage is not met after installation, the wrong gauge wire may have been used or the wiring run is too long.

### Wiring Example: ESH-A Remote Sensor

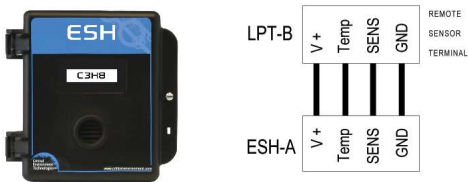

**The maximum length of wire between the ESH-A Remote Sensor and the transmitter should not exceed 61 m (200 ft).**

### 5.7.4 BACnet® Wire Gauge vs Run Length

This table shows the maximum cable length between the LPT-B and the BAS / DDC / controller for normal installations.

SUPPLY VOLTAGE	RS-485 BUS IMPEDENCE	WIRE GAUGE (AWG)	MAXIMUM CABLE LENGTH (feet)
22 VDC minimum	on board termination resistor available (J5)	low capacitance shielded wiring, 18 AWG	2000 at 76,800bps

## 6 SYSTEM OPERATION & CONFIGURATION

**NOTE:** The LPT-B can operate as part of a BACnet® network or as a standalone gas detection device.

When part of a BACnet® network, the LPT-B will continuously monitor gas concentrations on the configured channels and communicate the information back, when requested, to the BAS / DDC / controller via BACnet® MS/TP communications protocol. The BAS / DDC will read the LPT-B gas readings and it will trigger the responses (alarms, relays) as it has been configured.

If the BAS / DDC is not requesting information from the LPT-B or it is being used as a standalone device, the LPT-B will operate according to the gas readings, alarm setpoints and relay configurations as outlined in this manual. In the event of a gas build up in excess of the alarm setpoints, the internal alarm will sound and the relay will be triggered to activate a remote horn and/or strobe device, ventilation fans and/or some other safety procedure. When the gas level drops below the configured alarm point, the device will return to normal operation.



## 6.1 Navigating the Menu Structure

There are three push-buttons inside the enclosure that can be used to navigate through the LPT-B menu structure, or you can use the magnetic wand without needing to open the enclosure. The three magnetic sensors are indicated by an ARROW UP, ENTER and ARROW DOWN along the side of the enclosure. The magnetic sensors function the same as pressing the buttons inside the enclosure.



ARROW UP - used for going up through the menus or incrementing values or selecting an alpha character

ENTER - used primarily as an enter key, either for getting to the next screen or stepping through a numeric or alpha value

ARROW DOWN - used for scrolling down through the menus or decrementing values or selecting an alpha character

**NOTE:** The directions in this manual are given using the magnetic wand to engage the magnetic sensors on the side of the enclosure. However the same instructions can be followed when using the buttons inside the enclosure.

After entering the menus, pressing the ARROW UP key will normally take you to the Exit screen. Most menus are circular and will bring you back to the Exit screen.

## 6.2 Accessing the Menu with Passcodes

The main menu structure is broken down by the passcode access entry. These passcodes allow for direct access to the parts of the menu system of interest.

CODE	NAME	DESCRIPTION
1001	Hardware Configuration	<ul style="list-style-type: none"> <li>• Adjust Display Contrast</li> <li>• Program Audible               <ul style="list-style-type: none"> <li>• Enable / Disable Audible</li> <li>• Audible ON Delay</li> <li>• Audible Alarm setpoints (Low, Med, High, Fault)</li> <li>• Test Audible / Buzzer</li> </ul> </li> <li>• Program Relays               <ul style="list-style-type: none"> <li>• Enable / Disable Relays</li> <li>• Relay ON / OFF Delays</li> <li>• YES / NO Failsafe</li> <li>• Relay Alarm Setpoints (Low, Med, High, Fault)</li> <li>• Test Relay</li> </ul> </li> <li>• Change MAC ID</li> <li>• Change Base ID</li> <li>• Change Baud Rate</li> </ul>

3032

Sensor  
Configuration

- Enable / Disable Channels
- Calibrate Zero
- Calibrate Span
- Set Span Gas Value
- Set Channel Alarm Setpoints and Hysteresis (Setpoint Differential)
- Test Gas Reading Response
- Temp Local (used for factory troubleshooting only)
- Diagnostics (used for factory troubleshooting only)

## 6.3 Power Up and Warm-up

The current gas level reading can be monitored at any time during normal operation using the display. The display will be backlit when the menu is in active use.

Upon application of power, the device will enter the warm-up period and display a countdown of the time remaining before it is done warming up.

**NOTE:** The LPT-B will be visible on the BAS / DDC system during the warm-up countdown. A correct reading will not show up until the unit has finished the warm-up period.

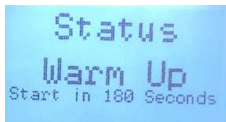

After the warm up period (3 minutes), the device may exhibit gas alarm conditions if the sensor has not completely stabilized during the warm up period. This is normal and the length of time the gas

alarm exists is dependent upon the length of time since the unit was last powered up and the state of the environment it is installed in. Refer to Section 5 *Installation* for more information.

## 6.4 Display Select

After warm up and upon normal operation, the display will cycle through and show a summary of the status of the gas readings for each enabled channel / sensor. This is the factory default position.



If the LPT-B is part of a system, such connected to a QCC or FCS, each gas channel splash screen will show the current status of the channel:

- OK - gas channel is operating normally
- LOW - gas channel is in low alarm
- MID - gas channel is in mid alarm
- HIGH - gas channel is in high alarm
- FAULT - gas channel is in fault
- COMM - control panel / BAS has been unable to communicate with the LPT-B for at least 300 seconds

For each status (except OK), the backlight will be illuminated, making it easier to find the gas detector from far away.

**NOTE:** If the LPT-B is being used as a standalone system (not connected to a controller or BAS), these statuses do not appear.

Using the magnetic wand (or buttons inside the enclosure) you can scroll through the other splash screens that show the devices' serial number, version number, BACnet® Base, MAC and Baud ID setting and current internal temperature reading inside the enclosure.



## 6.5 Set LCD Display Contrast Level

The contrast level of the LCD display can be changed to be made more visible in high light, low light and/or different temperatures that may require a different contrast setting.

In the Hardware Configuration Menu (passcode 1001), press either ARROW to scroll through the menu and select Contrast Adjust. Press ENTER to select. Use the ARROW keys to enter a number between 00 and 35. The factory default contrast level is 20.

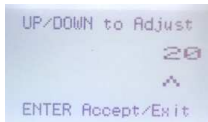

## 6.6 Fault Detection

The LPT-B has built in fault detection, and in the event of a problem with the measurement circuitry the transmitter will indicate a fault condition on the display. Normal operation will resume once the fault condition has been corrected.

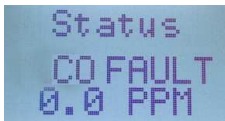

**NOTE:** While faults in the circuitry can be detected, a dead or damaged electrochemical sensor will usually appear to the transmitter as a zero gas reading. To ensure safe operation, periodic bump tests are required.

## 6.7 BACnet® Settings

You can view all the current BACnet® settings in the Hardware Configuration menu on a summary screen, prior to proceeding to change the settings. In the Hardware Configuration menu (passcode 1001), press either ARROW until the BACNET screen appears:



### 6.7.1 Change BACnet® MAC ID

The factory set default MAC ID is 100. The MAC ID along with the Base ID make up the complete ID for the device. Each device requires a unique ID in order to communicate with the BAS / DDC. The MAC ID address should be set for each LPT-B during installation.

To change the MAC ID, in the Hardware Configuration Menu (passcode 1001), press either ARROW to scroll through the menu and select BACnet MAC.

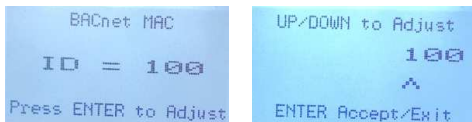

Press ENTER and use the ARROW keys to change the ID number. Move to the next digit by pressing ENTER. When finished, press ENTER to save and Exit.

### 6.7.2 Change BACnet® Base ID

The factory set default Base ID is 270, which is CETCI's Vender ID. If you need to change the Base ID, in the Hardware Configuration Menu (passcode 1001), press either ARROW to scroll through the menu and select BACnet Base.

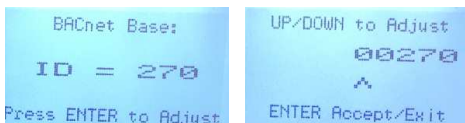

### 6.7.3 Change BACnet® Baud Rate

All devices on the same network must have the same baud rate. The default BACnet® baud rate for the LPT-B is 76,800. If you need to change the baud rate, in the Hardware Configuration Menu (passcode 1001), press either ARROW to scroll through the menu and select BAUD.



Press ENTER and use the ARROW keys to scroll through the baud rates to choose from:

- 9,600
- 14,400
- 19,200
- 38,400
- 57,600
- 76,800 (default, configurable)
- 115,200

Select the preferred baud rate by pressing ENTER to save and Exit.

#### **6.7.4 BACnet® Holding Registers**

Critical Environment Technologies Canada Inc. (CETCI) has been granted the BACnet® Testing Laboratories (BTL) certification for the CETCI BACnet® Module upon passing the BTL requirements for the BACnet® Smart Actuator (B-SA) designation. To see our BTL Listing go to:

<https://www.bacnetinternational.net/btl/index.php?m=81>

To look at the PICS for the LPT-B, go to:

<https://www.critical-environment.com/media/download/manuals/CETCI-BACnet-Module-Insert.pdf>

If you have specific requirements, have any questions or require clarification about the BACnet® holding registers, please contact CETCI for assistance.

### **6.8 Alarm / Buzzer Operation**

The LPT-B has an internal buzzer (alarm) that can be enabled or disabled, assigned to a channel alarm level setpoint and configured to have an ON Delay. The buzzer is linked to the backlight of the display, so that in an alarm condition, the backlight of the display will flash on and off. The alarm and the flashing display can be stopped for a period of time by pressing the ENTER button.



### 6.8.1 Enable / Disable Audible

The factory default for the buzzer setting is ENABLED.

In the Hardware Configuration Menu (passcode 1001), press either ARROW to scroll through the menu and select Program Audible. Press ENTER to select.



Scroll through the menu and choose Audible Enable. Press ENTER to choose between ON or OFF.

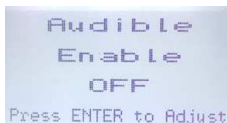

### 6.8.2 Audible ON Delay

You can set the buzzer to be delayed in sounding for a specified period of time after the LPT-B has gone into an alarm state. If the alarm state is neutralized before the time delay expires, the device returns to normal operation.

In the Hardware Configuration Menu (passcode 1001), press either ARROW to scroll through the menu and select Program Audible.

Press ENTER and use the ARROW keys to scroll through the menu and select Audible Delay On.

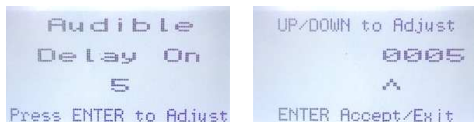

Press ENTER and use the ARROW keys to increase or decrease the number of seconds. Move to the next digit by pressing ENTER. When finished, press ENTER to save and Exit.

**NOTE:** The maximum length of time you can set the audible delay on for is 9999 seconds (2.7 hours). Factory default is 1 second. To have no delay in sounding the buzzer, enter 0000.

### 6.8.3 Audible Alarm Level Assignment

You can choose one level of alarm at which the buzzer will sound. Choose from LOW, MID, HIGH or FAULT.

**NOTE:** The LOW, MID and HIGH setpoints of the alarm levels are configured in the Sensor Configuration Menu. Refer to Section 6.11 *Setting Channel Alarm Setpoints*.

In the Hardware Configuration Menu (passcode 1001), press either ARROW to scroll through the menu and select Program Audible. Press ENTER and use the ARROW keys to scroll through the menu and select Audible Alarms. Press ENTER and use the ARROW keys to scroll through the choices. Press Enter to save and Exit.

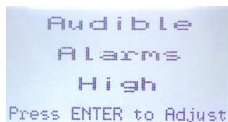

## 6.9 Relay Operation

The LPT-B has one dry contact relay that are designed to operate fans or to control equipment that draws no more than 30 volts, 2 amps start-up and / or operational current. The system does not provide any power from these terminals. Dry contacts operate like a switch to simply activate (switch on) or de-activate (switch off) equipment to be controlled, such as fan starters.

The relay is SPDT (single pole, double throw) thereby providing one set of usable dry contacts for the relay. Because the LPT-B system is designed to be fail-safe, any equipment to be controlled by the system relay should be wired to the “NC” (Normally closed) and “COM” (Common) terminals.

**The relay coils are normally energized in non-alarm state for failsafe operation.**

### 6.9.1 Enable / Disable Relay

The relay in the LPT-B can be enabled or disabled. The factory default for the relay setting is enabled. If the relay is disabled it will not be able to be controlled by the BAS / DDC.

In the Hardware Configuration Menu (passcode 1001), press either ARROW to scroll through the menu and select Program Relay. Press ENTER to select.

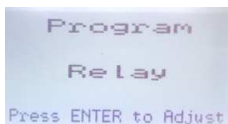

Scroll through the menu and choose Relay Enable. Press ENTER to choose between ON or OFF.

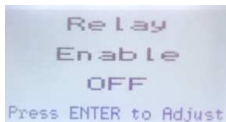
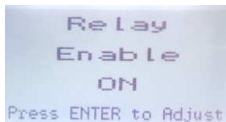

## 6.9.2 Setting Relay ON / OFF Delay

The LPT-B comes with a configurable ON and OFF delay for its relays. In the event of a gas build up in excess of the level set for the specified alarm level, the relay will be triggered. If an ON DELAY has been set, the relay will remain unchanged until the time delay has expired, at which time the relay will “trip”. If the gas level falls below the set alarm level before the delay has finished, the alarm will be cancelled and the delay will be reset for the next alarm. If an OFF DELAY has been set, the relay will stay tripped for the duration of the RELAY OFF DELAY.

**NOTE:** Each channel will trip the relay according to that channel’s alarm setpoints and relay alarm level assignment setting.

### To set the Relay ON DELAY:

In the Hardware Configuration Menu (passcode 1001), press either ARROW to scroll through the menu and select Program Relay. Press ENTER to select. Scroll through the menu and choose Relay Delay On.

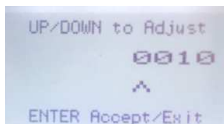
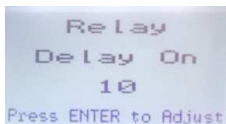

Press ENTER to access the screen and use the ARROW keys to increase or decrease the number. Press ENTER to move to the next digit and again to save and Exit the screen.

### To set the Relay OFF DELAY:

In the Hardware Configuration Menu (passcode 1001), press either ARROW to scroll through the menu and select Program Relay. Press ENTER to select. Scroll through the menu and choose Relay Delay OFF.

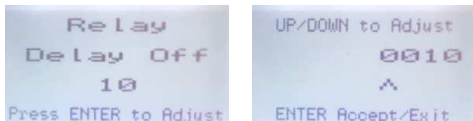

Press ENTER to access the screen and use the ARROW keys to increase or decrease the number. Press ENTER to move to the next digit and again to save and Exit the screen.

**NOTE:** The ON Delay and OFF Delay are entered in seconds. The maximum length of time that either can be set to is 9999 (2.7 hours). The default setting from the factory is 0000 seconds, indicating no ON or OFF Delays are set.

### 6.9.3 Relay Mode of Operation (Normal or FAILSAFE)

The LPT-B is designed to be fail-safe so the relay is normally energized in a non-alarm state for failsafe operation. If required, the LPT-B can be configured for normal relay operation.

In the Hardware Configuration Menu (passcode 1001), press either ARROW to scroll through the menu and select Program Relay. Press ENTER to select. Scroll through the menu and choose Relay Failsafe. Press ENTER to select Yes or No. Press the DOWN ARROW to save and Exit the screen.

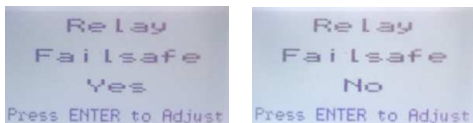

### 6.9.4 Relay Alarm Level Assignment

One level of alarm can be set to trigger the relay. Choose from LOW, MID, HIGH or FAULT.

**NOTE:** The LOW, MID and HIGH setpoints of the alarm levels are configured in the Sensor Configuration Menu. Refer to Section 6.11 *Setting Channel Alarm Setpoints*.

In the Hardware Configuration Menu (passcode 1001), press either ARROW to scroll through the menu and select Program Relay. Press ENTER and use the ARROW keys to scroll through the menu and select Relay Alarms. Press ENTER and use the ARROW keys to scroll through the choices. Press Enter to save and Exit.

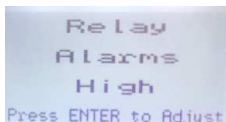

## 6.10 Test Functions

### 6.10.1 Test Audible / Buzzer

**NOTE:** Before testing the audible alarm / sounding the buzzer, warn people in the vicinity of the sound so unnecessary distress or response is not caused.

In the Hardware Configuration Menu (passcode 1001), press either ARROW to scroll through the menu and select Program Audible. Press ENTER and use the ARROW keys to scroll through the menu and select Audible Test. Press ENTER and use the ARROW keys to increase or decrease the number of seconds. You can enter a maximum number of 9999 seconds (2.7 hours).



Move to the next digit by pressing ENTER. When finished, press ENTER to save and Exit. The test will

start immediately and will continue for as long as the time was set. The remaining time of the test can be seen counting down on the display. You can exit the menu without affecting the time. **If you want to end the test before the time is up, you must re-enter the Test Mode and enter a value of "0000" for the test length of that function.**

## 6.10.2 Test Relay

**NOTE:** Before testing the relay, notify the appropriate people so unnecessary distress or response is not caused.

In the Hardware Configuration Menu (passcode 1001), press either ARROW to scroll through the menu and select Program Relay. Press ENTER and use the ARROW keys to scroll through the menu and select Relay Test. Press ENTER and use the ARROW keys to increase or decrease the number of seconds. You can enter a maximum number of 9999 seconds (2.7 hours).

Move to the next digit by pressing ENTER. When finished, press ENTER to save and Exit.

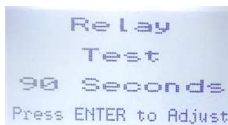
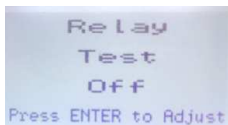

The test will start immediately and will continue for as long as the time was set. The remaining time of the test can be seen counting down on the display. You can exit the menu without affecting the time. **If you want to end the test before the time is up, you must re-enter the Test Mode and enter a value of "0000" for the test length of that function.**

**NOTE:** Relay ON delay does NOT apply during the test, however Relay OFF delay will apply when the test times out. If the relays were tested (tripped) they will remain so after testing for the duration of their respective OFF delay. (Refer to Section 6.9.2 *Setting Relay ON / OFF Delay*).

### 6.10.3 Test Gas Reading Response / Send Test Reading to Controller

**NOTE:** Before conducting this test, notify the appropriate people so unnecessary distress or response is not caused.

**NOTE:** This functionality is available in firmware version 1.29 onwards.

This test allows you to send a forced gas reading to the controller without having to expose the sensor to actual gas, so you can make sure the LPT-B is connected to the controller properly after installation and is still initiating an appropriate response from the controller during routine maintenance checks. The test only applies to the channel you have chosen.

In the Sensor Configuration Menu (passcode 3032) press either ARROW key to scroll through the menu and select the channel for which you want to test the gas reading response.

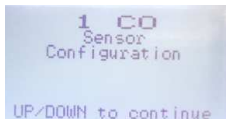
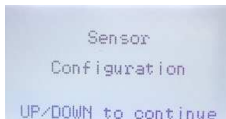

Press ENTER and use the ARROW keys to scroll through the menu and choose TEST. Press ENTER and use the ARROW key to increase or decrease the value and the ENTER key to move to the next digit.

**NOTE:** You will only be able to enter a value that falls within the factory configured range of the sensor. If you try to enter a number outside that limit, the value will return to a valid value.

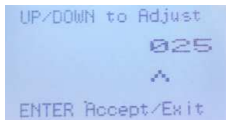
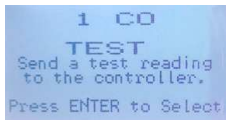



When finished, press ENTER to accept and Exit the screen. The gas level reading for that channel will be immediately sent to the controller. This test reading will override any actual gas reading for that channel for the duration of the test.

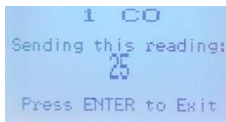

To stop the test, press ENTER to Exit. If you do not exit the test, the test will timeout after 5 minutes and return to normal operation. Repeat for each channel you want to test.

## 6.11 Setting Channel Alarm Setpoints

The LPT-B is configurable as a one, two or three channel gas detector and each channel has three gas alarm setpoints, LOW, MID and HIGH which can be ascending or descending. The number entered as the setpoint is the exact number at which the alarm will be triggered, unless a hysteresis value has been set (refer to Section 6.11.4 *Setting Hysteresis*). The setpoint is the level of the gas concentration at (and above which) the relay will be activated, the buzzer will sound (if enabled) and the display will indicate an alarm condition (if enabled). Almost all installations will use the factory default alarm setpoints.

**NOTE:** If Channel 1 is not being set, follow the same steps using Channel 2 and/or Channel 3.

### 6.11.1 LOW Alarm Setpoint

In the Sensor Configuration Menu (passcode 3032), press either ARROW key to scroll through the menu and select the channel for which you are setting the alarm setpoint.

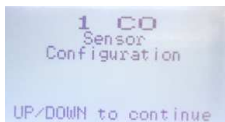
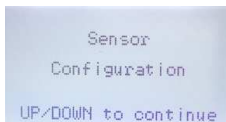

Press ENTER and use the ARROW keys to scroll through the menu and choose SP Low. Press ENTER and use the ARROW key to choose ASCENDING or DESCENDING.

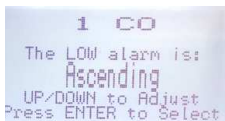
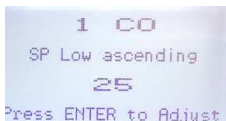

Press ENTER again to change the setpoint value by using the ARROW keys to increase or decrease the number. Press ENTER to move to the next digit and again to save and Exit the screen.

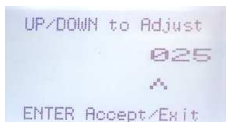

**NOTE:** An Ascending alarm is used when the normal gas level starts out below the alarm setting and when the reading goes above it, the alarm will trip. A descending alarm is used when the normal gas level starts above the alarm setting and when the reading goes below it, the alarm will trip. The descending alarm is commonly used with Oxygen sensors.

### 6.11.2 MID Alarm Setpoint

Follow the same procedure as the *6.11.1 LOW Alarm Setpoint*, choosing the SP Mid menu option.

### 6.11.3 HIGH Alarm Setpoint

Follow the same procedure as the *6.11.1 LOW Alarm Setpoint*, choosing the SP High menu option.

Default setpoints are as follows:

SENSOR GAS TYPE	LOW ALARM	MID ALARM	HIGH ALARM
Carbon Monoxide (CO)	25 ppm	50 ppm	100 ppm
Nitrogen Dioxide (NO <sub>2</sub> )	0.7 ppm	1.0 ppm	1.5 ppm
Combustibles (catalytic)	10% LEL	15% LEL	20% LEL

### 6.11.4 Setting Hysteresis

Hysteresis is the difference between the ON point and OFF point of the alarm. You can set a hysteresis value that will be common for all alarm setpoints on that channel. For example, if the alarm is set to come on at 100 ppm and the hysteresis is set for 5 ppm, the alarm will not turn off until the gas is below 95 ppm. This prevents the alarm from chattering on and off repetitively if the gas fluctuates just above and just below 100 ppm.

In the Sensor Configuration Menu (passcode 3032), press either ARROW key to scroll through the menu and select the channel for which you are setting the hysteresis value. Scroll through the menu options to SP Diff and press ENTER to select.

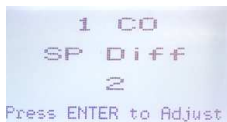

Use the ARROW keys to increase or decrease the number. Press ENTER to move to the next digit and again to save and Exit the screen.

## 6.12 Enable / Disable Channels

This setting allows you to enable or disable the channel(s). If a channel with a viable sensor is disabled, the gas readings gathered by that channel will not be used to control the relays and/or alarms.

In the Sensor Configuration Menu (passcode 3032), press either ARROW key to scroll through the menu and select the channel you want to disable.

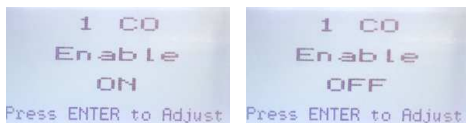

Press ENTER and use the ARROW key to scroll to the Enable screen. Use the ENTER key to choose ON or OFF. Use the ARROW key to move on to the next menu item and ENTER to Exit.

## 7 CALIBRATION

### 7.1 Calibration Specifications

#### 7.1.1 Gas

Calibration span gases should have at least  $\pm 5\%$  accuracy and have a current date stamp. Gas generators should have a current dated cell installed. Service personnel should flow zero emissions air or 20.9% volume  $O_2$  (scrubbed of hydrocarbons) before attempting to null adjust toxic gas sensors. In some cases nitrogen ( $N_2$ ) can be substituted for zero air when null adjusting electrochemical sensors. Contact CETCI for clarification.

Every LPT-B transmitter is calibrated in a chamber by true diffusion method prior to leaving our facility. This method more closely emulates actual "real world" conditions. Field calibration using gas cylinder, regulator and hose directing span gas into the sensor may result in slightly

higher readings. It is important to note that the type of gas mixture, how old the gas is and what temperature it has been stored at will also affect repeatability during field calibration.

**NOTE:**

- Oxygen sensors require 99.9% N<sub>2</sub> for a true zero and span is done first, followed by zero.
- Catalytic sensors require oxygen to work and thus the user **MUST** flow clean air or oxygen to obtain a true zero and the span gas must have “air” balance, not N<sub>2</sub> balance.

### 7.1.2 Regulators & Flow

Calibration gases that are lighter than or the same weight as air (CO, O<sub>2</sub>, etc.) should be flowed at 0.5 LPM. Gases heavier than air (NO<sub>2</sub>, etc.) should be flowed between 0.5 and 1.0 LPM. Fixed flow regulators provide more accuracy.

### 7.1.3 Adapters

The proper calibration adapter should be utilized to allow the gas to properly diffuse around the sensor. The calibration adapter plug for an LPT-B with an internal sensor without a splash guard is part number **CET-7000-CAP**. For an LPT-B with a splash guard, you will need to use the Cal Clip, part number **CET-SGC**.

### 7.1.4 Calibration Frequency

- Parking garage detectors: Once every 12 months
- OHS applications: Once every 6 months (OHS: Occupational Health & Safety)
- For best performance and to meet published specifications: once every six months

**NOTE:** A calibration label should be applied after every calibration to confirm work performed and the date it was confirmed. If a controller is involved, the alarm set points should be indicated on a label on the front door of the enclosure so anyone working in the environment can be aware.

Equipment: Calibration Kit, Calibration gases, Digital multi-meter, magnetic wand

Users can order the calibration kit, calibration accessories and / or gases from any CETCI authorized distributor or you can supply your own gas and equipment as long as the gas meets the minimum specifications. CETCI does not ship gas cylinders outside of Canada.

### 7.1.5 Gas Testing Frequency (Bump Testing)

For the purpose of safety in OHS applications, sensors should be gas tested (bump tested) once every month to confirm response and alarm activation.

### 7.1.6 Sticky Gases

Sticky gases, such as Ozone ( $O_3$ ), Chlorine ( $Cl_2$ ) and Hydrogen Chloride (HCl) adhere to surfaces including tubing and splash guards. When calibrating a sticky gas sensor we suggest using Teflon lined tubing so the gas doesn't adhere to the tubing, reducing the concentration of the flow of gas. Also keep the length of the tubing as short as possible, no more than 0.91 to 1.22 m / 3 - 4 ft so the gas flow concentration doesn't lessen over the distance from the gas cylinder to the sensor. If a splash guard is required for an LPT-B BACnet® Transmitter with an Ozone, Chlorine, Chlorine Dioxide, Hydrogen Chloride, Hydrogen Cyanide or Phosphine sensor the special sticky gas splash guard (Option -SN) must be ordered.

It is also suggested that when calibrating a Chlorine sensor, you use a chlorine gas generator due to the instability of Chlorine gas in a cylinder and the fact that it is difficult to get accurate readings from that source.

### 7.1.7 Non-Intrusive Calibration

Calibration can normally performed without opening the unit by using a magnetic wand to engage the magnetic sensors that are on the side of the enclosure. Refer to Section 4.1 *Exterior Enclosure* for location photo. This is particularly useful if in a wet or dirty environment. A magnet of sufficient strength will be required to trip the sensors. Such a magnet is included in the Calibration Kit (refer to Section 8.6 *Calibration Kit*) and can also be ordered separately from CETCI under part number **CET-MW** (refer to Section 8.4 *Magnetic Wand*).

To initiate non-intrusive calibration, touch the magnet to one of the marks on the side of the enclosure and follow the screen prompts along with the instructions in this section.

**NOTE:** The programming buttons inside the enclosure can be used instead of the magnetic wand, if preferred.

## 7.2 Calibrating the Internal Sensor(s)

**NOTE:** If calibrating an Oxygen sensor, refer to Section 7.5 *Calibrating an Oxygen Sensor*.

To calibrate the internal sensor(s), the user must go through the following steps:

### Step 1

In the Sensor Configuration Menu (passcode 3032), press either ARROW key to scroll through the menu and select the channel you want calibrate. Press ENTER and use the ARROW key to scroll to Calibrate Zero. Press ENTER and use the ARROW keys to enter a value of 0.

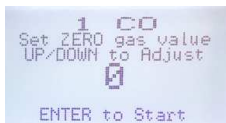
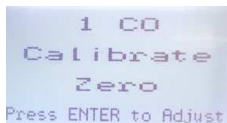

Attach the regulator to the cylinder of zero air, insert calibration adapter into the sensor opening on the front of the enclosure door (refer to Section 7.3.1 *Calibration Adapter Plug* if the adapter will not fit). Press Enter to start the Zero calibration. The display will show a countdown from 18 seconds.

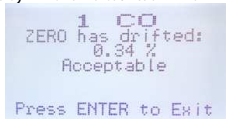

When the process has finished and the Zero calibration was accepted, press ENTER to Exit and remove the cylinder of zero gas. Refer to Section 7.3.3 *Zero - Requires Override* if the Zero calibration was not successful.

**NOTE:** After 5 minutes of inactivity, the display will return to the normal operation.

## Step 2

Set the span calibration gas level. It is important to make sure that the span gas level value matches the calibration gas concentration you are using to calibrate the sensor.

The factory default calibration gas concentrations are:

SENSOR GAS TYPE	CALIBRATION GAS LEVEL
Carbon Monoxide (CO)	100 ppm
Nitrogen Dioxide (NO <sub>2</sub> )	5 ppm
Combustibles	20% LEL

In the Sensor Configuration Menu (passcode 3032), press either ARROW key to scroll through the menu and select the channel you want calibrate. Press ENTER and use the ARROW key to scroll to Calibrate Span. Press ENTER and use the ARROW keys in increase or decrease the span gas value.

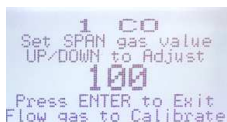
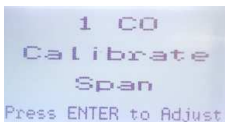

When the correct value is displayed, attach the regulator to the span gas cylinder and flow the span gas over the sensor. Once gas is detected, display will show a countdown from 180 seconds (3



minutes).

**NOTE:** If an inappropriate concentration of span gas is applied during calibration, calibration may succeed but it does not mean the equipment has been calibrated properly. CETCI is not responsible for improperly calibrated transmitters. Follow manual instructions carefully.

When the process has finished and the Span calibration was accepted, remove the cylinder of span gas. Refer to Section 7.3.4 *Span - Requires Override* if the Span calibration was not successful.

Repeat the calibration steps above for each enabled gas channel.

**NOTE:** After 5 minutes of inactivity, the display will return to the normal operation.

**NOTE:** If required, the Zero Calibration and the Span Calibration procedures can be done independently of each other. Refer to Section 7.3.2 *Zero Calibration Shift* for more information.

## 7.3 Trouble Shooting Calibration

This section is intended to aid in correcting issues that may arise during the calibration procedure. If you are unable to correct a problem or you have questions, please contact our Technical Service Department at [help@cetci.com](mailto:help@cetci.com) or 604-940-8741 (Local) or 1877-940-8741 (Toll Free).

### 7.3.1 Calibration Adapter Plug

Use a slight twisting motion as you gently push the calibration adapter plug (p/n: **CET-7000-CAP**) into the sensor opening. If it is hard to insert, moisten the O-ring seal slightly then try re-inserting it. If the splash guard is installed, use the Cal Clip (p/n: **CET-SGC**).

**NOTE:** Response time will be slower with the splash guard installed.

### 7.3.2 Zero Calibration Shift

If all that is desired is to do a zero calibration shift, complete Step 1 in Section 7.2 *Calibrating the Internal Sensor(s)*. A zero shift calibration is only done when the LPT-B is being installed for the first time. The reason for a zero shift calibration is to compensate for the new environment in which the LPT-B is being installed.

### 7.3.3 Zero - Requires Override

If the gas level (possible residual gas) is too high, but still within the override range, the display will indicate that an override is required.

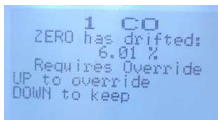

To override the value use the UP ARROW to select the desired value. To keep the original zero value, use the DOWN ARROW. Press ENTER to Exit.

### 7.3.4 Span - Requires Override

During the Span calibration, readings are taken and from the results sensitivity is calculated and compared to the original sensitivity of the sensor at the time of installation. If this sensitivity is below the override range, but above the fault limit, the display will indicate that an override is required. To override the value use the UP ARROW to select the desired value. To keep the original value, use the DOWN ARROW. Press ENTER to Exit.

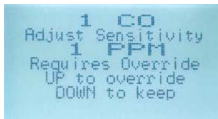

### 7.3.5 Fault Reading

If the LPT-B is giving a fault reading then either the LPT-B has failed a previous calibration and cannot calculate the expected voltage, or there has been a fault that the LPT-B cannot correct for. In either case all that can be done is to attempt a complete calibration from the beginning (Step 1) and determine if this corrects the fault. If a calibration does not resolve the fault then the LPT-B may need a new sensor. If that does not correct the fault, please contact our Technical Service Department at [help@cetci.com](mailto:help@cetci.com).

### 7.3.6 Calibration Failure

If the calibration fails while calibrating one of the sensors, you can try to calibrate it again, but more than likely the sensor needs replacing. Over time, a sensor has degrades and when it has gone beyond an acceptable level, it has reached its end of life and will no longer pass a calibration.

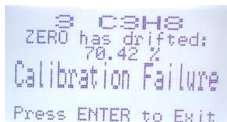

## 7.4 Calibrating an ESH-A Remote Sensor Connected to an LPT-B

There are two different processes for calibrating an ESH-A Remote Sensor. One process is for a new or replacement sensor and the other is for a properly functioning sensor. For either process, first ensure that the sensor has been continually powered for at least 24 hours.

### 7.4.1 Zero and Span Calibration of a Responsive ESH-A Remote Sensor (done at the LPT-B)

If the sensor does not need to be replaced and is responding correctly, the Zero and Span

calibrations will need to be done at LPT-B transmitter that the ESH-A is connected to.

In the Sensor Configuration Menu (passcode 3032), press either ARROW key to scroll through the menu and select the channel the ESH-A is assigned to. Follow the instructions in Section 7.2 *Calibrating the Internal Sensor(s)* **with the exception of applying the gas to the ESH-A sensor opening instead of the LPT-B sensor opening.**

### 7.4.2 Zero Calibration of a New or Replacement ESH-A Remote Sensor

If a new replacement sensor has been installed, the ESH-A will require a zero calibration of its sensor. This process will normally be required if the sensor has been replaced or there is concern that the sensor is not responding correctly.

Make sure the ESH-A Remote Sensor is powered up and has been warmed up for a 48 hour period prior to calibration.

#### Step 1

Open the ESH-A Remote Sensor enclosure. Move the jumpers from their resting position to JP1-1 and JP1-2 (bottom two jumper positions).

#### Step 2

Apply the correct Null gas for the type of sensor installed, for a minimum of 2 minutes.

#### Step 3

Attach a volt meter to TP1 and TP2. Using the POT RN1 potentiometer (located on the left underside of the ESH-A board), adjust the voltage to read 0.40 VDC. Verify that the voltage output from digital multi-meter leads attached to test points TP1 and TP2 on the LPT-B is reading 0.0 VDC (a Zero and Span Calibration of the LPT-B will be required if this is not the case).

#### Step 4

Return the jumpers to their original positions and close the ESH-A.

#### Step 5

On the LPT-B, in the Sensor Configuration Menu (passcode 3032), press either ARROW key to scroll through the menu and select the channel the ESH-A has been assigned to. Follow the instructions in Section 7.2 *Calibrating the Internal Sensor(s)* **with the exception of applying the gas to the ESH-A sensor opening instead of the LPT-B sensor opening.**

## 7.5 Calibrating an Oxygen Sensor

When calibrating an Oxygen sensor, the process is reversed. A Span Calibration must be done first, then a Zero Calibration. The Zero Calibration is done using a cylinder of 99.9% Nitrogen (N<sub>2</sub>) gas.

#### Step 1

In the Sensor Configuration Menu (passcode 3032), press either ARROW key to scroll through the menu and select the channel with the Oxygen sensor you want to calibrate. Press ENTER and use the ARROW key to scroll to Calibrate Span.

Set the span calibration gas level. It is important to make sure that the span gas level value matches the calibration gas concentration you are using to calibrate the sensor.

The factory default calibration gas concentration is:

SENSOR GAS TYPE	CALIBRATION GAS LEVEL
Oxygen (O <sub>2</sub> )	20.9% VOL

Either use a cylinder of 20.9% Oxygen or if you are confident of the air quality, the oxygen in the breathing environment can be used as a fairly accurate source of span gas (be careful not to exhale

in the direction of the Oxygen sensor vent). It is not suggested to use this procedure for all span adjustments of Oxygen sensors.

If using a cylinder, attach the regulator to the cylinder of Oxygen and insert calibration adapter into the sensor opening on the front of the enclosure door (refer to Section 7.3.1 *Calibration Adapter Plug* if the adapter will not fit). Once gas is detected, display will show a countdown from 180 seconds (3 minutes).

When the process has finished and the Span calibration was accepted, remove the cylinder of span gas. Refer to Section 7.3.4 *Span - Requires Override* if the Span calibration was not successful.

**NOTE:** If an inappropriate concentration of span gas is applied during calibration, calibration may succeed but it does not mean the equipment has been calibrated properly. CETCI is not responsible for improperly calibrated transmitters. Follow manual instructions carefully.

**NOTE:** After 5 minutes of inactivity, the display will return to the normal operation.

**NOTE:** If doing a respan after installation stop here. Refer to Section 5.1 *Special Considerations for Different Types of Sensors*.

## Step 2

In the Sensor Configuration Menu (passcode 3032), press either ARROW key to scroll through the menu and select the channel with the Oxygen sensor you want to calibrate. Press ENTER and use the ARROW key to scroll to Calibrate Zero. Press ENTER and use the ARROW keys to enter a value of 0.

Attach the regulator to the cylinder of Nitrogen ( $N_2$ ), insert calibration adapter into the sensor opening on the front of the enclosure door (refer to Section 7.3.1 *Calibration Adapter Plug* if the

adapter will not fit). The Zero Calibration will start when the flow of gas is detected.

When the process has finished and the Zero calibration was accepted, press ENTER to Exit and remove the cylinder of Nitrogen gas. Refer to Section 7.3.3 *Zero - Requires Override* if the Zero calibration was not successful.

## 8 ACCESSORIES

### 8.1 Splash Guard (Option -S)

The splash guard attaches to the front of the enclosure to protect the sensor during water spray or washdown applications. It is factory installed and when attached the enclosure meets IP54 standards. To calibrate a device with a splash guard, use the Cal Clip.



**NOTE:** A specialize splash guard (Option -SN) must be used for sticky gas sensors such as Ozone ( $O_3$ ), Chlorine ( $Cl_2$ ), Chlorine dioxide ( $ClO_2$ ), Hydrogen chloride (HCl), Hydrogen cyanide (HCN) and Phosphine ( $PH_3$ ).

**NOTE:** The splash guard will slow down the response time of the sensor.

### 8.2 Calibration Adapter Clip “Cal Clip” (p/n: CET-SGC)

To calibrate an LPT-B with a factory installed splash guard (Option -S), attach the Cal Clip around the splash guard. The small barb hose fitting accommodates standard or Teflon tubing of 1/8” (3.175 mm) ID and 3/16” (4.762 mm) ID. The Cal Clip **must be removed during normal operation** or else the gas readings will not be accurate.



### 8.3 Magnetic Wand (p/n: CET-MW)

The magnetic wand is used for accessing menu options and program functions without opening the enclosure. Use to engage the magnetic sensors on the side of the LPT-B.



Lift Strength	226.7 g (½ lb) solid steel
Size	66.6 mm x 6.35 mm (2 5/8" X 1/4") Hexagon

### 8.4 Metal Protective Guard (p/n: SCS-8000-RSG)

The metal protective guard (p/n: **SCS-8000-RSG**) is made of heavy gauge, galvanized metal and helps protect against abrasive damage, theft and vandalism to the transmitters. The 16-gauge galvanized steel has 13 mm (½ in) square openings in the front to allow gas and air to flow through to the sensor. With only four slotted mounting holes, installation and removal for gas detector servicing is easy. In applications where sticky gases are being monitored, such as Ozone, Chlorine, Hydrogen Chloride, etc. and frequent wash-downs are required, the metal guard can be ordered with a splash cover (p/n: **SCS-8000-WSG**). The splash cover is made of a material that allows the sticky gas to reach the sensor without adhering to the vent opening, plus protects the sensor from water ingress.



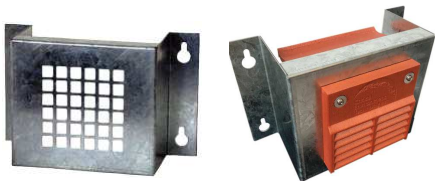

Enclosure	16 gauge galvanized steel
Weight	800 g (28 oz)
Size	178 mm W x 160 mm H x 91 mm D (7.0" W x 6.3" H x 3.6" D)

## 8.5 Calibration Kit (p/n: CET-715A-CK1)

The Calibration Kit contains the items necessary for common field and shop calibrations. It comes in a durable, hard plastic carrying case and includes a regulator, adapters, humidification chamber, brass fitting, hand tools and tubing. It does not include cylinders of gas. These must be ordered separately. Calibration Kits and gases are available from the CETCI factory. Many gases, but not all are carried in inventory. Check with any CETCI authorized distributor for availability of specific gas types. **Gas cylinders cannot be shipped from Canada to other countries, including the USA.**



## 9 MAINTENANCE

The LPT-B transmitter requires virtually no maintenance other than regular calibration of the sensor(s).

The transmitter should be monitored for possible damaging conditions.

- The sensor vent should be kept free of dirt or soot build up.
- If in a damp location, source of water should be shielded from contacting the top of the transmitter.
- If located in a working area, the front of the transmitter should be kept clear.
- If painting is to be conducted in the transmitter's location the transmitter needs to be protected from over spray and the sensor vent should not receive paint fumes – these fumes may damage and/or reduce the life of the sensor.

It is important to ensure that excess water and/or dust is not somehow entering the enclosure and physically damaging the circuit board or internal components.

## 10 TROUBLE SHOOTING

### **LPT-B won't power up. (blank display)**

Is the power properly connected? Check the connections. Refer to Section 5.7 *Wiring Connections*. Check the display contrast. Refer to Section 6.5 *Set LCD Display Contrast Level*.

### **Display shows a channel status FAULT message.**

The LPT-B is in fault mode. If re-calibrating the sensor fails, replace the sensor.

### **Display shows "Calibration Failure".**

The span calibration failed. Try to recalibrate the sensor again. If re-calibrating the sensor fails, replace the sensor.

### **LPT-B powered up (display appears normal) but the control panel displays "Fault".**

BACnet® output signal has not been connected properly. Check the connections and refer to the Wiring Examples in Section 5.7 *Wiring Connections*.

### **Device cannot be seen by the Controller and/or the BAS / DDC on the BACnet® network.**

Check the Baud rate. All devices in the network must have the same Baud rate. Refer to Section 6.7.3 *Change BACnet® Baud Rate*.

Check to make sure the device has a unique ID assigned to it, which is made up of the MAC ID and the Base ID. Refer to Sections 6.7.1 *Change BACnet® MAC ID* and 6.7.2 *Change BACnet® Base ID*.

Check that local area network wiring is correct, especially the A and B lines to make sure they are not swapped between devices on the network.

**Frequent, unexpected alarm conditions.** Check to see if EMI and RF interference is causing the equipment to react this way. Refer to Section 5.5.2 *EMI and RF Interference Considerations* for more information.

**Diagnostic information for Technical Service Support use.** To fast track troubleshooting issues with our technicians, before emailing or calling our Technical Service Department, please take a picture of the diagnostic screen and include it in your email. If you are calling, please have this information ready to relay to our technician.

In the Sensor Configuration Menu (passcode 3032) press either ARROW key to scroll through the menu and select the gas channel for which you want to see the diagnostic information. Press ENTER and then the UP ARROW key to see this diagnostics screen.

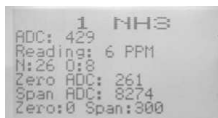

ADC	The current Analog to Digital Count number
Reading	The final gas reading after all filters
N	The new sensitivity in ADC per unit of the Reading (ie. 26 ADC/PPM)
O	The original sensitivity in ADC per unit of the Reading (ie. 8 ADC/PPM)
Zero ADC	The ADC used at Zero calibration
Span ADC	The ADC used at Span calibration
Zero	The gas reading at Zero (in the same units as the Reading)
Span	The gas reading at Span (in the same units as the Reading)







## **Critical Environment Technologies Canada Inc.**

Unit 145, 7391 Vantage Way, Delta, BC, V4G 1M3, Canada

Toll Free: +1.877.940.8741

Tel: +1.604.940.8741

Fax: +1.604.940.8745

[www.critical-environment.com](http://www.critical-environment.com)

