



MVR-300™

Refrigerant Gas Detector for Occupied Spaces

User Manual

Installation • Operation • Configuration • Troubleshooting

P/N: 6203-9000
August 2018
Revision 3



Product Leadership • Training • Service • Reliability

WARRANTY POLICY

Bacharach, Inc. warrants this detector, excluding sensors, to be free from defects in materials and workmanship for a period of 12 months from the date of purchase by the original owner. The sensor has a pro-rated warranty period of 12 months. If the product should become defective within this warranty period, we will repair or replace it at our discretion.

The warranty status may be affected if the detector has not been used and maintained per the instructions in this manual or has been abused, damaged, or modified in any way. This detector is only to be used for purposes stated herein. The manufacturer is not liable for auxiliary interfaced equipment or consequential damage.

Due to ongoing research, development, and product testing, the manufacturer reserves the right to change specifications without notice. The information contained herein is based on data considered accurate. However, no warranty is expressed or implied regarding the accuracy of this data.

All goods must be shipped to the manufacturer by prepaid freight. All returned goods must be pre-authorized by obtaining a return merchandise authorization (RMA) number. Visit www.mybacharach.com for an RMA number and procedures required for product transport.

SERVICE POLICY

Bacharach, Inc. maintains a service facility at the factory. Some Bacharach distributors/agents may also have repair facilities; however, Bacharach assumes no liability for service performed by anyone other than Bacharach personnel. Repairs are warranted for 90 days after date of shipment (sensors, pumps, filters and batteries have individual warranties). Should your detector require non-warranty repair, you may contact the distributor from whom it was purchased or you may contact Bacharach directly.

If Bacharach is to do the repair work, send the detector, prepaid, to the closest Service Center.

Location	Contact Information	Shipping Address
United States	Phone: 724-334-5000 Toll Free: 800-736-4666 Fax: 724-334-5001 Email: help@mybacharach.com	Bacharach, Inc. 621 Hunt Valley Circle New Kensington, PA 15068, USA <i>ATTN: Service Department</i>
Europe	Phone: +353 1 284 6388 Fax: +353 1 284 6389 Email: help@mybacharach.com	Bacharach, Inc. 114A Georges Street Lower Dun Laoghaire, Dublin, Ireland <i>ATTN: Service Department</i>
Canada	Phone: 905-882-8985 Fax: 905-882-8963 Email: support@bachcan.ca	Bacharach, Inc. 10 West Pearce Street, Unit 4 Richmond Hill, Ontario LB4 1B6, Canada <i>ATTN: Service Department</i>

Always include your RMA #, address, telephone number, contact name, shipping/billing information and a description of the defect as you perceive it. You will be contacted with a cost estimate for expected repairs prior to the performance of any service work. For liability reasons, Bacharach has a policy of performing all needed repairs to restore the detector to full operating condition.

Prior to shipping equipment to Bacharach, visit www.mybacharach.com for an RMA # (returned merchandise authorization). All returned goods **must** be accompanied with an RMA number.

Pack the equipment well (in its original packing, if possible), as Bacharach cannot be held responsible for any damage incurred during shipping to our facility.

NOTICES

This manual is subject to copyright protection; all rights are reserved under international and domestic copyright laws. This manual may not be copied or translated, in whole or in part, in any manner or format, without the written permission of Bacharach, Inc.

All software utilized and/or distributed by Bacharach is subject to copyright protection. All rights are reserved. No party may use or copy such software in any manner or format, except to the extent that Bacharach grants them a license to do so. If this software is being loaded onto more than one computer, extra software licenses must be purchased.

MVR-300™ is a trademark of Bacharach, Inc. All rights reserved.

TABLE OF CONTENTS

SECTION 1. SAFETY	5
1.1 Definition of Alert Icons.....	5
1.2 General Safety Statements	5
1.3 Safe Connection of Electrical Devices	6
SECTION 2. DESCRIPTION.....	7
2.1 Product Overview	7
2.2 Intended Use	7
2.3 Design Features	7
2.4 Components Overview	8
SECTION 3. INSTALLATION.....	10
3.1 General Information for Installation	10
3.2 Mechanical Installation	10
3.3 Configuration	12
3.4 Electrical Installation	14
SECTION 4. OPERATION.....	17
4.1 Start-up.....	17
4.2 Alarm Management Function and Configuration.....	17
4.2.1 Default Alarm Function.....	17
4.2.2 Alarm Delay – Switches 2 and 3	18
4.2.3 Failsafe – Switch 4	20
4.2.4 Alarm 2 Relay – Switch 5	20
4.2.5 Latching Alarm State – Switch 6	20
4.2.6 Buzzer Disable – Switch 7.....	20
4.3 Other Switch Configurations.....	21
4.3.1 Reset (Cycle Power) - Switch 1.....	21
4.3.2 Reset to Factory Default Values - Switch 8.....	21
4.4 Operation of Magnetic Switches, Buzzer, and LED	22
SECTION 5. MAINTENANCE.....	23
5.1 Maintenance Intervals	23
5.2 Adjustments.....	23
5.2.1 Introduction.....	23
5.2.2 General Procedure	24
5.2.3 Zero Adjustment	25
5.2.4 Span Adjustment	25
5.2.5 Bump Test	26
5.3 Troubleshooting.....	26
5.3.1 Failed Span Adjustment	26
5.3.2 Hexadecimal Format	27
5.3.3 Fault Conditions.....	28
5.3.4 Fatal Faults	29
5.3.5 Critical Faults	29
5.3.6 Negative Gas Fault	29
5.3.7 Non-Critical Faults	29
5.4 Replacing the Sensor Module	30
5.5 Cleaning the Detector	31
SECTION 6. SENSOR PRINCIPLE.....	32
SECTION 7. DISPOSING OF THE DETECTOR	32
SECTION 8. TECHNICAL DATA.....	33
8.1 Approvals.....	33
8.2 Specifications for Modbus RTU Digital Communication over RS-485	33
8.3 Power Supply and Relay Specifications	33
8.4 Wiring Specifications	33
8.5 Physical Specifications	34





MVR-300™ Refrigerant Gas Detector

8.6	Environmental Specifications	34
8.7	Sensor Specifications	34
8.8	Default Alarm Levels	34
8.9	Modbus Registers.....	35
8.9.1	Read Device Identification.....	35
8.9.2	Analog Input Registers	35
8.9.3	Analog Output Registers	37
8.9.4	Input Status Flags.....	38
8.9.5	Output Status Flags.....	39
SECTION 9.	ORDERING INFORMATION	41
9.1	MVR-300 Refrigerant Leak Detector Configurations.....	41
9.2	MVR-300 Refrigerant Leak Detector Configurations (UK Version).....	41
9.3	Accessories	42
SECTION 10.	CUSTOM UK BACK BOXES AND FACEPLATES	43
10.1	Introduction to UK Version.....	43
10.2	Hardware Overview – UK Version.....	43
10.3	Using Optional Metal Tabs	44
10.4	Electrical Installation – UK Version	44
10.5	Customizing Face Plates.....	45
10.6	Calibration.....	46

SECTION 1. SAFETY

1.1 Definition of Alert Icons

The following alert icons are used in this document to highlight areas of the associated text that require a greater awareness by the user.

Alert	Icon	Description
DANGER		Indicates an imminently hazardous situation which, if not avoided, will result in death or serious injury.
WARNING		Indicates a potentially hazardous situation which, if not avoided, could result in death or serious injury.
WARNING		Indicates a potential electrical shock hazard which, if not avoided, could result in death or serious injury.
CAUTION		Indicates a potentially hazardous situation which, if not avoided, could result in physical injury or damage to the product or environment. It may also be used to alert against unsafe practices.
NOTICE		Indicates additional information on how to use the product.

1.2 General Safety Statements

- Before using this product, carefully read and strictly follow the instructions in the manual.
- Use the product only for the purposes specified in this document and under the conditions listed.
- Ensure that product documentation is retained, made available, and appropriately used by anyone operating the product.
- Comply with all local and national laws, rules, and regulations associated with this product.
- Only trained and competent personnel may use this product.
- Only trained and competent personnel may inspect, repair and maintain the product as detailed in this manual. Maintenance that is not detailed in this manual must be completed by Bacharach or personnel qualified by Bacharach.
- Use only genuine Bacharach spare parts and accessories. Otherwise, operation may be impaired.
- Only operate the product within the framework of a risk-based alarm signaling concept.



CAUTION

REFRIGERANT SUFFOCATION RISK: Large refrigerant leaks into occupied spaces can reach concentrations that pose a suffocation risk to the occupants. While the MVR-300 can be used to detect refrigerant leaks well below those concentrations, it is not designed as a stand-alone safety device. Safety of the occupants must take a system design approach including ventilation, detection, early warning, mitigation, and design redundancy among other considerations.

1.3 Safe Connection of Electrical Devices

Before connecting this detector to electrical devices not mentioned in this manual, consult the manufacturer or a qualified professional.



NOTICE

The sensor must be connected by a marked, suitably located and easily reached switch or circuit-breaker as means of disconnection.



NOTICE

If replacement of either main power fuse is required, use only a TR5 Radial 3.15A 250V slow fuse (Littlefuse 372 1315 0001 or equivalent).



CAUTION

Wiring must be in compliance with national and local wiring codes.



CAUTION

RS-485 signal cable must be insulated to the highest voltage level in the system. Protect the RS-485 signal cable by using the supplied installation kit.

SECTION 2. DESCRIPTION

2.1 Product Overview

The Bacharach MVR-300 continuously checks the ambient air of occupied spaces for refrigerant leaks. The detector is for indoor applications. It is housed in an ABS enclosure that fits into many 2-gang and most 3-gang electrical back boxes (not included).



NOTICE

The MVR-300 is designed for use in 2-gang and 3-gang back boxes with a minimum depth of 47 mm (1.9"). Metal United Kingdom (UK) back boxes are also supported, but require a special UK version of the MVR-300, slightly modified installation, and a customized faceplate (not supplied by Bacharach). Otherwise, the UK version is functionally the same. Refer to Chapter 10 for more information on the UK version and its differences.



Figure 1. MVR-300 with Examples of Supported 2-gang Back Boxes

Gas alarms and status messages are indicated visually by a 3-colored LED and audibly by a buzzer. In case of an alarm and / or fault, relays switch (for example, to shut-off valves or to activate alarm devices).

2.2 Intended Use

- Checks ambient air of occupied spaces for refrigerant leaks
- Intended for indoor applications
- ABS enclosure fits into many 2-gang and most 3-gang electrical back boxes (not included)
- Can be operated as a stand-alone detector or connected to a BMS/BAS (Building Management/Building Automation) System
- Designed to be installed in non-classified, non-hazardous, permanent locations.

2.3 Design Features

- Powered by 100 to 240 VAC, 50/60 Hz
- Gas alarms and status messages are indicated visually by a 3-colored LED and audibly by a buzzer
- In case of an alarm and/or fault, relays can switch shut-off valves, alarm devices, or indicators at a BMS/BAS
- Measured gas concentration, status signals and configuration information are accessible via the Modbus RTU interface (see Section 8.9 on page 34)
- Can be calibrated and maintained non-intrusively using a magnetic wand

2.4 Components Overview

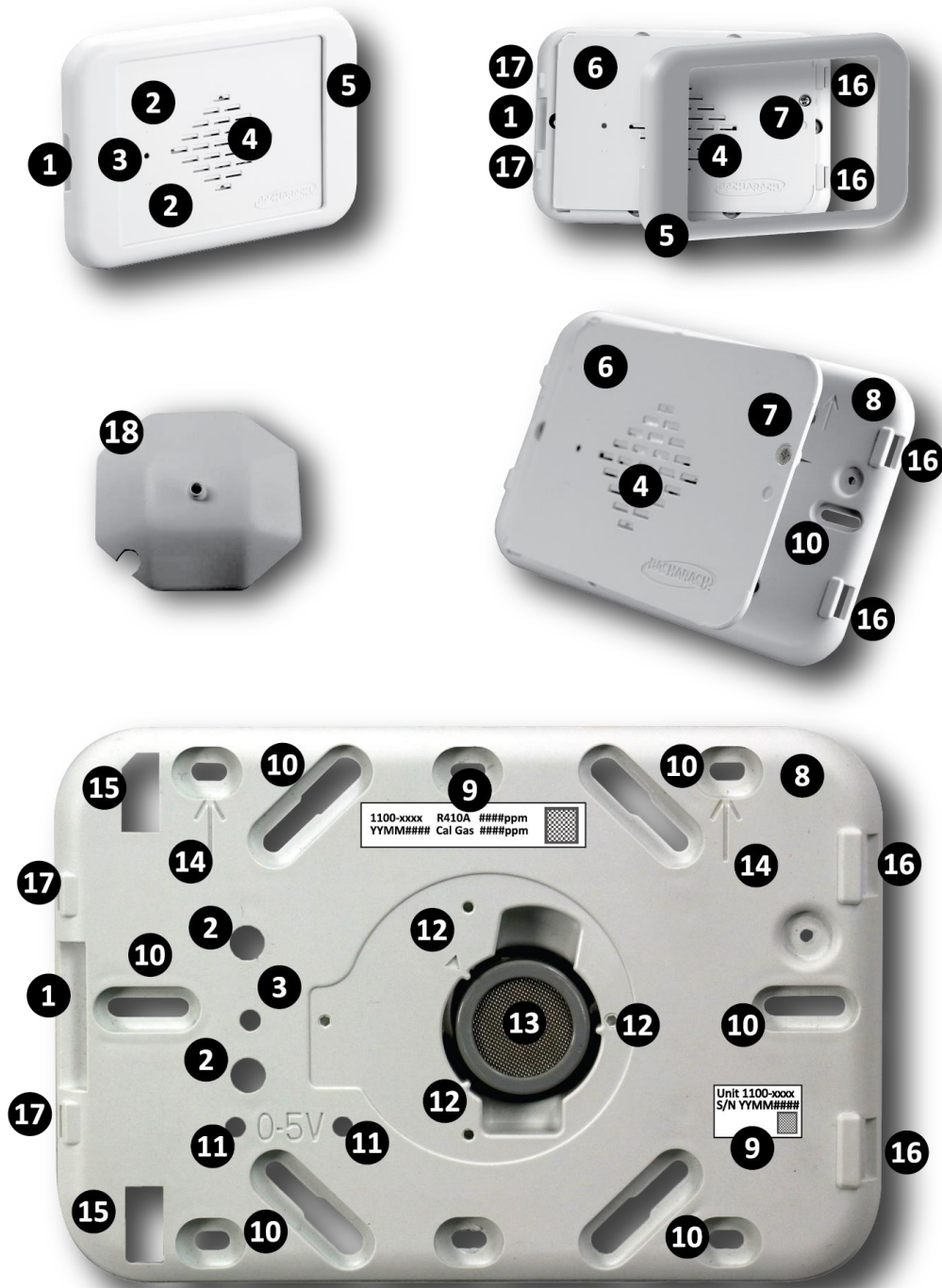

Figure 2. MVR-300 Components (Front)



Figure 3. MVR-300 Components (Back)

Item	Description of MVR-300 Components in Figure 2 and Figure 3
1	Coin slot to release bezel
2	Magnetic switch positions 1 (● on top) and 2 (●● on bottom)
3	Multi-color status LED
4	Grill
5	Decorative snap-on bezel
6	Cover plate (hinged)
7	Captive set screw
8	Detector base
9	Sensor type/calibration and ID/serial number labels
10	Mounting slots (×6)
11	Test point access holes (×2)
12	Sensor alignment ribs (×3)
13	Replaceable sensor module
14	Direction arrows (×2) for proper mounting
15	Hinges for cover plate
16	Hinges for bezel
17	Snap locks for bezel
18	Calibration adapter (fits cover plate and detector base)
19	Firmware version and part number/calibration labels
20	Configuration DIP switches (1-8)
21	Relay 1 output connectors (low gas alarm)
22	Relay 2 output connectors (high gas alarm or fault)
23	Power connectors
24	Modbus serial communications connectors
25	Rubber boot for Modbus port
26	Wiring harness

SECTION 3. INSTALLATION

3.1 General Information for Installation

Every detail of installation location is critical to ensure overall system performance and effectiveness. Strict compliance and considerable thought must be given to every detail of the installation process, including, but not limited to the following:

- Regulations as well as local, state, and national codes that govern the installation of gas detection equipment
- Electrical codes that govern the routing and connection of electrical power and signal cables to gas detection equipment
- The full range of environmental conditions to which the detectors will be exposed (refer to section 6: Sensor Principle on page 32 for more information on ambient conditions and cross-sensitivity)
- The physical characteristics of the gas or vapor to be detected
- The specifics of the application (e.g., possible leaks, air movement/draft, etc.)
- The degree of accessibility required for maintenance purposes
- The types of optional equipment and accessories that will be used with the system
- Any limiting factors or regulations that would affect system performance or installations
- Wiring details, including the following:
 - Wiring must be connected as indicated in this manual.
 - The wiring for power and relays must be selected and fused according to the rated voltages, currents, and environmental conditions.
 - If stranded conductors are used, a ferrule should be used.
 - A switch or circuit breaker must be included in the installation.
 - The switch or circuit breaker must be suitably located and easily reached.
 - The switch or circuit breaker must be marked as the disconnect device for the equipment.

3.2 Mechanical Installation

- The detector fits in most 2-gang and 3-gang electrical back boxes (not included) (See Section 10 for details on the custom UK version of the MVR-300)
- The detector must be accessible for maintenance (e.g., adjustment)
- The access pathway of the refrigerant gas to the sensor must not be obstructed
- The detector should be installed about 4 to 6 inches (100 to 150 mm) above the floor level



Figure 4. A Sampling of 2-Gang Electrical Boxes Supported by the MVR-300

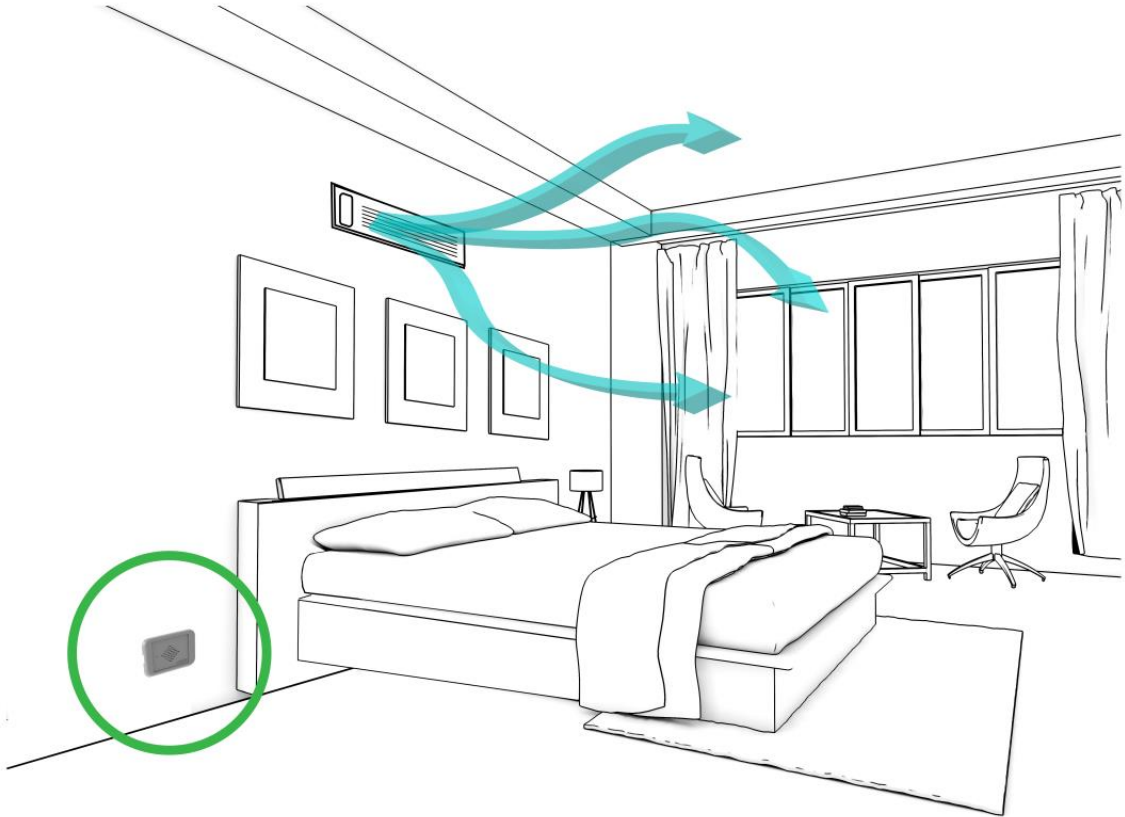

Figure 5. Typical MVR-300 Installation in an Occupied Space Application

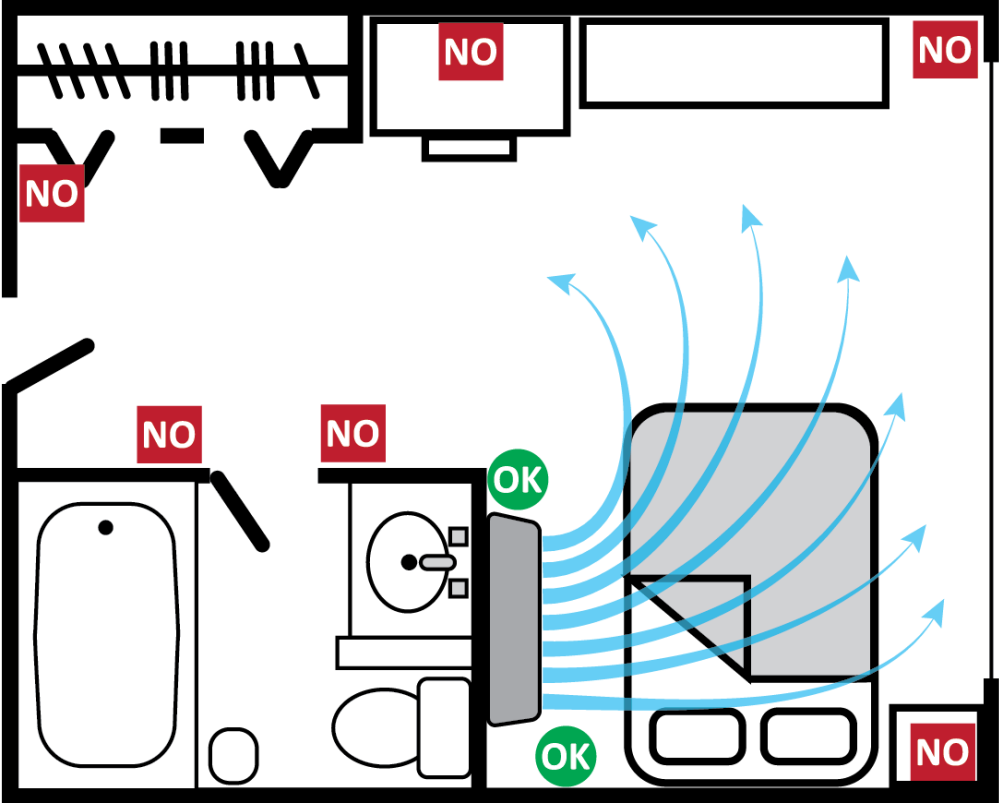

Figure 6. Recommended Installation Locations

3.3 Configuration

Configuration is accomplished via switches or from a Remote Terminal Unit (RTU) on a Modbus serial communications network. Review the default settings to determine if they are suitable for your particular application. If default values are not suitable, change the configuration using the DIP switches, or via the Modbus interface. A summary of switches is shown below. For details on Modbus communications registers, refer to Section 8.9: Modbus Registers on page 35.



NOTICE

By default, switch configurations supersede Modbus configurations. Use Modbus register 2007 (Modbus Precedence over DIP Switch Settings) to change this precedence.

Changes of configurations will not take effect until the detector is restarted (i.e., toggling switch 1 or cycling power).



NOTICE

For a proper reset, switch 1 must be toggled (ON then OFF). If it is left ON, the detector is held in reset mode and will not function correctly until the switch is returned to the OFF position.

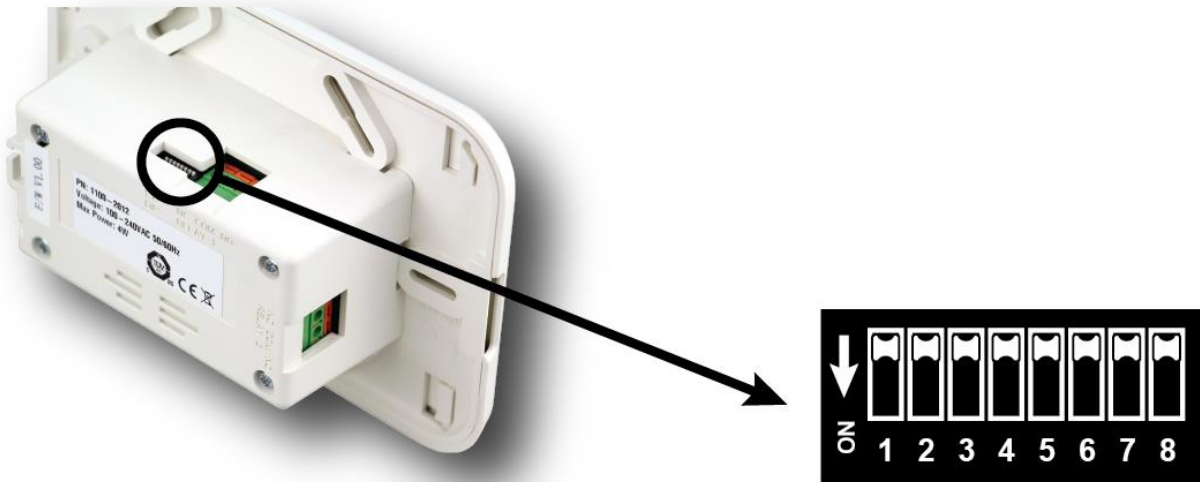

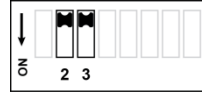
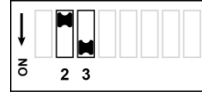
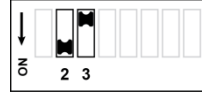
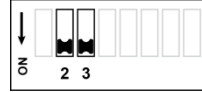

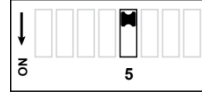









Figure 7. Switches for Configuring the MVR-300

Switch	Function	Options and Descriptions	Positions
1	Restart	Off = Normal Operation (default)	
		On = Restart MVR-300 (must return switch to OFF position)	
2, 3	Alarm ON Delay	Off, Off = No delay (default)	
		Off, On = 5 minute delay	
		On, Off = 10 minute delay	
		On, On = 15 minute delay	
4	Failsafe Relay Selection	Off = Normal Relay Operation (default)	
		On = Failsafe Relay Operation	
5	Relay 2 Fault Indication	Off = High Alarm or Fault (default)	
		On = High Alarm Only	
6	Alarm Latching	Off = Alarms automatically reset (default)	
		On = Alarms latch and require manual reset	
7	Buzzer Disable	Off = Buzzer enabled (default)	
		On = Buzzer disabled	
8	Reset Detector Settings to Factory Default Values	Off = Normal operation	
		On = Used in reset procedure for resetting Modbus registers to their factory default values (see section 4.3.2 on page 21 for reset information and section 8.9 on page 35 for Modbus registers and default values).	

3.4 Electrical Installation



CAUTION

A switch or circuit breaker must be included in the installation. The switch or circuit breaker must be suitably located and easily reached, and it must be marked as the disconnect device for the equipment.



CAUTION

Ensure all wiring connections are made *before* applying power.



CAUTION

This product uses semiconductors which can be damaged by electrostatic discharge (ESD). When handling the printed circuit boards (PCBs), observe proper ESD precautions so that the electronics are not damaged.



CAUTION

RS-485 signal cable must be insulated to the highest voltage level in the system. Protect the RS-485 signal cable by using the supplied installation kit.



CAUTION

Wiring must be in compliance with national and local wiring codes.



NOTICE

When inserting wire into the terminal, release the spring clamp by pushing the release latch back.

Step	Description of Electrical Installation											
1.	Remove bezel by releasing the two snap locks. When installed, insert coin into the slot to remove.											
2.	Remove cover plate by loosening the set screw.											
3.	Observing proper polarity, connect wires for power to the appropriate terminals. <table border="1" data-bbox="315 1377 802 1619"> <thead> <tr> <th>Power</th> <th>Label</th> <th>Wiring Termination</th> </tr> </thead> <tbody> <tr> <td rowspan="2">100 to 240 VAC</td> <td>L</td> <td>VAC line</td> </tr> <tr> <td>N</td> <td>VAC neutral</td> </tr> <tr> <td>Earth Ground</td> <td>G</td> <td>VAC earth ground</td> </tr> </tbody> </table> 	Power	Label	Wiring Termination	100 to 240 VAC	L	VAC line	N	VAC neutral	Earth Ground	G	VAC earth ground
Power	Label	Wiring Termination										
100 to 240 VAC	L	VAC line										
	N	VAC neutral										
Earth Ground	G	VAC earth ground										

Figure 8. Wiring Power

Step	Description of Electrical Installation
------	--

4. Observing proper polarity, connect normally closed (NC) common (COM), and normally open (NO) wires for relays to the appropriate terminals.

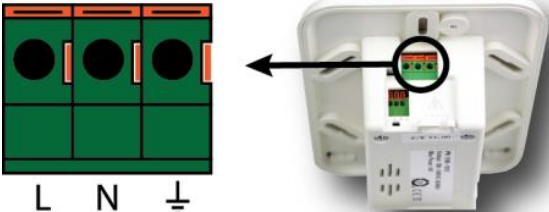

Figure 9. Wiring Relay 1 (Low Gas Alarm) and Relay 2 (High Gas Alarm or Fault)

5. Observing proper polarity, make the Modbus connections as follows, using the figures below for reference.

Label	Description
A	RS-485 "A" (non-inverted)
B	RS-485 "B" (inverted)
G	RS-485 shield

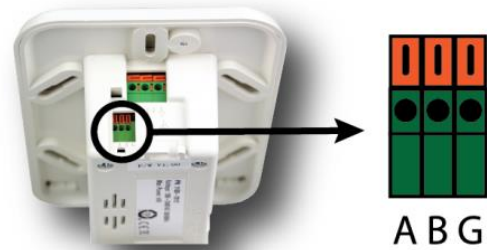
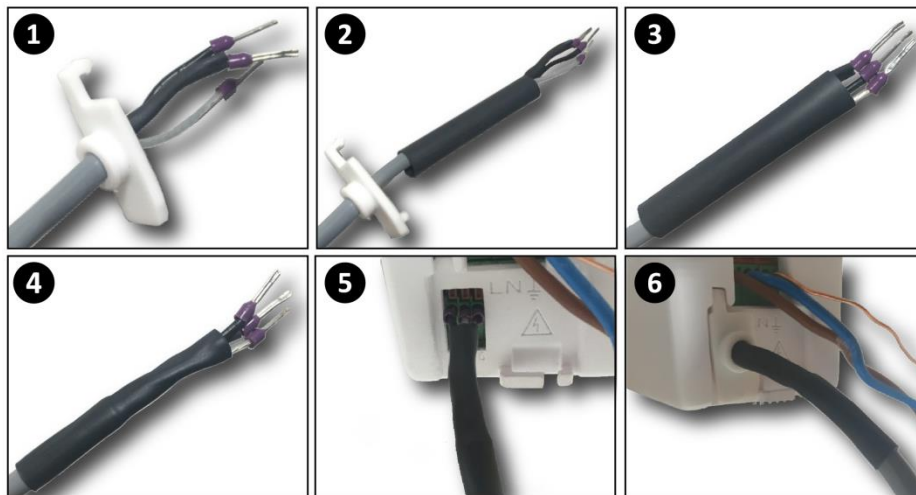
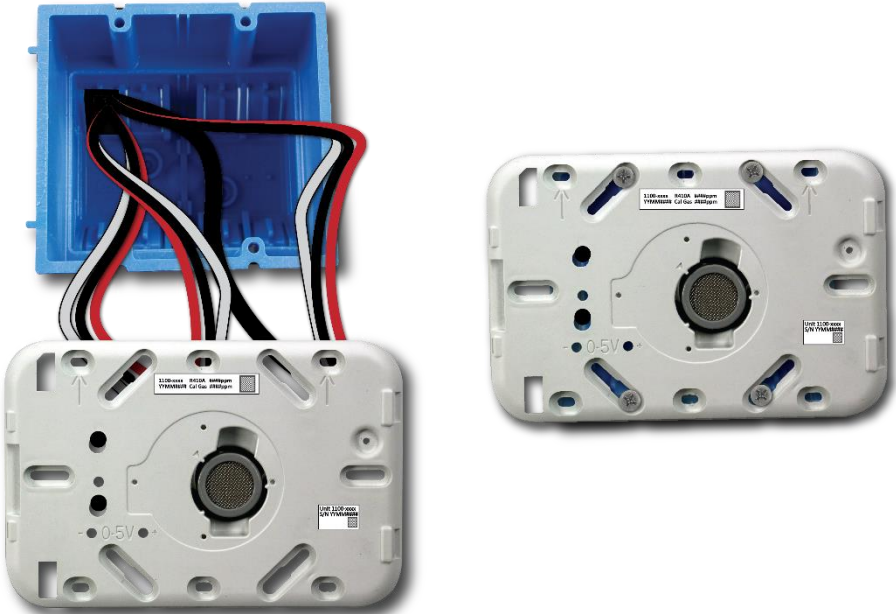



Figure 10. Modbus Wiring Terminals



- Prepare signal cable and put boot over the signal cable (1).
- Add ferules if required (2).
- Apply 10 cm piece of shrink wrap as close to the wire ends/ferules as possible while leaving some free wire to allow connection to the detector (3).
- Heat the shrink wrap (4).
- Connect signal wires/ferules to the detector (5).
- Slide rubber boot along the wire and shrink wrap assembly and connect it to the detector (6).

Figure 11. Details for Connecting Modbus Communications Wiring

Step	Description of Electrical Installation
6.	Confirm configuration of switches. Refer to Section 3.3 on page 12.
7.	<p data-bbox="315 268 1425 331">Place detector into electrical back box (not included) and secure through the appropriate mounting slots.</p>  <p data-bbox="487 982 1263 1012">Figure 12. Secure the MVR-300 and Wiring into the Back Box</p>
8.	<p data-bbox="315 1029 987 1058">Put cover plate back into hinge and tighten the set screw.</p>  <p data-bbox="600 1457 1146 1486">Figure 13. Replace and Secure Cover Plate</p>
9.	<p data-bbox="315 1499 818 1528">Put the bezel back into hinge and snap on.</p>  <p data-bbox="691 1877 1058 1906">Figure 14. Replace the Bezel</p>

SECTION 4. OPERATION

4.1 Start-up

Step	Description
1.	Switch power on.
2.	Observe start-up sequence and warm-up phase. <ul style="list-style-type: none"> • Green LED will blink at 0.5 Hz for about 5 minutes • Modbus flag for warm-up is set • Buzzer is off • Relay state is “no alarm”
3.	Observe normal operation. <ul style="list-style-type: none"> • Green LED is steady on • Buzzer is off • Relay state is “no alarm”
4.	A bump test or calibration is required following installation to verify instrument functionality. (See Section 5.2.5 for more information.)

4.2 Alarm Management Function and Configuration

The MVR-300 offers several different ways how the detector behaves in case of a refrigerant alarm. The alarm manager can either be configured through the switches or the Modbus interface.

4.2.1 Default Alarm Function

If the refrigerant concentration raises above the alarm 1 set-point:

- The LED flashes red with 0.5 Hz
- The buzzer beeps at 0.5 Hz
- The alarm 1 relay changes state
- The Modbus alarm 1 flag is set.

Once the alarm 1 condition is no longer present and below the hysteresis value (imposed to avoid relay chatter), the detector returns to normal operation.

If the refrigerant concentration raises above the alarm 2 set-point:

- The LED flashes red with 2 Hz.
- The buzzer beeps at 2 Hz
- The alarm 2 relay changes state
- The Modbus alarm 2 flag is set.

Once the alarm 2 condition is no longer present and below the hysteresis value (avoiding relay chatter), the detector returns to alarm 1 state.

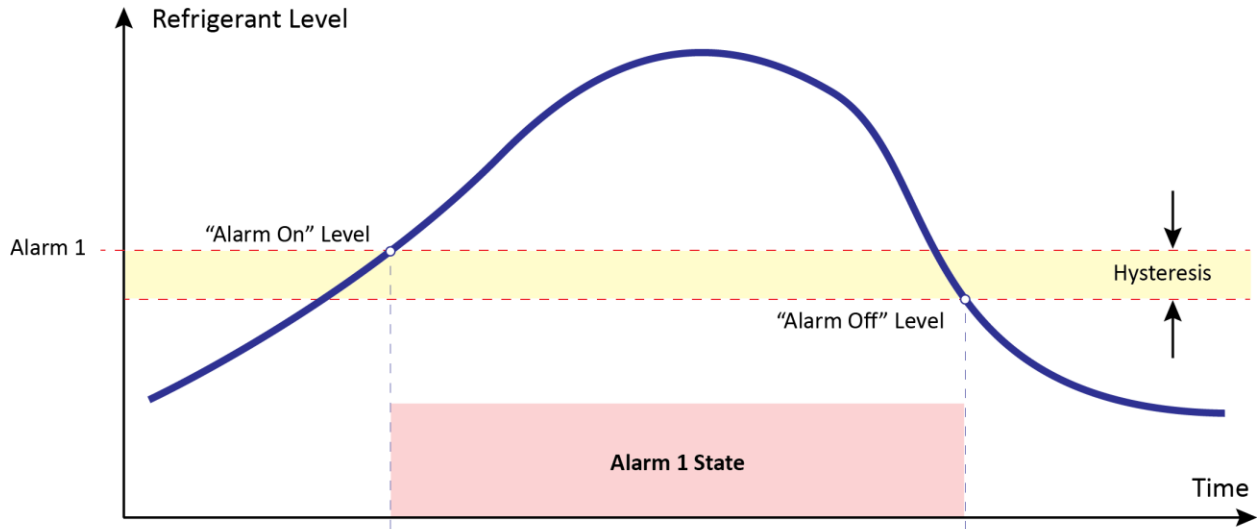

Figure 15. Default Alarm Generation

4.2.2 Alarm Delay – Switches 2 and 3

To avoid premature alarms, ensuring the presence of refrigerant for a certain amount of time, the triggering of the alarm can be delayed for a short period of time. Unless the alarm condition is present for at least the delay time, the alarm will not be triggered.

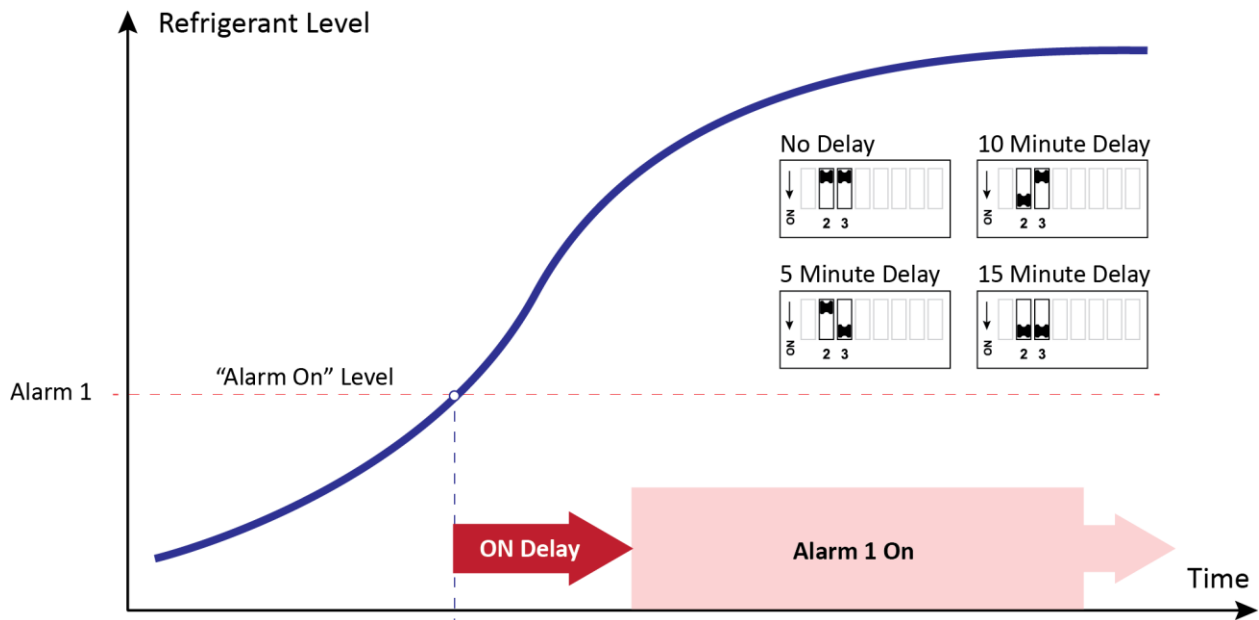

Figure 16. Alarm ON Delay (Alarm Condition Must Be Present for at Least the Programmed Time)

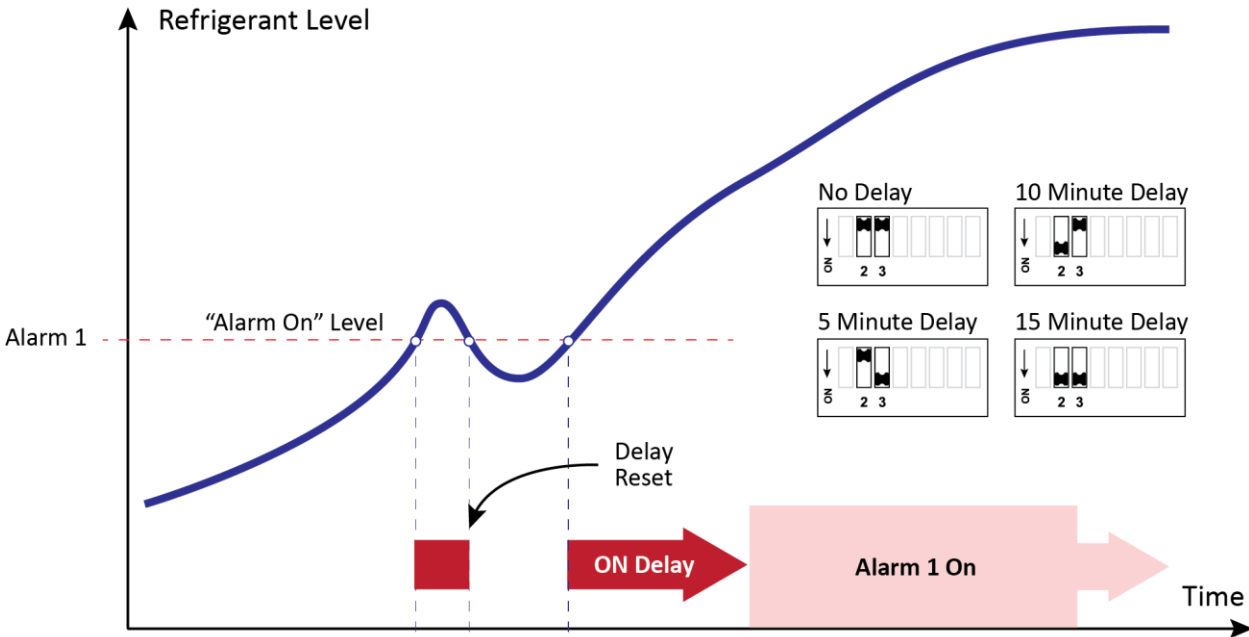

Figure 17. Alarm ON Delay (A Shorter Delay Time Is Disregarded)

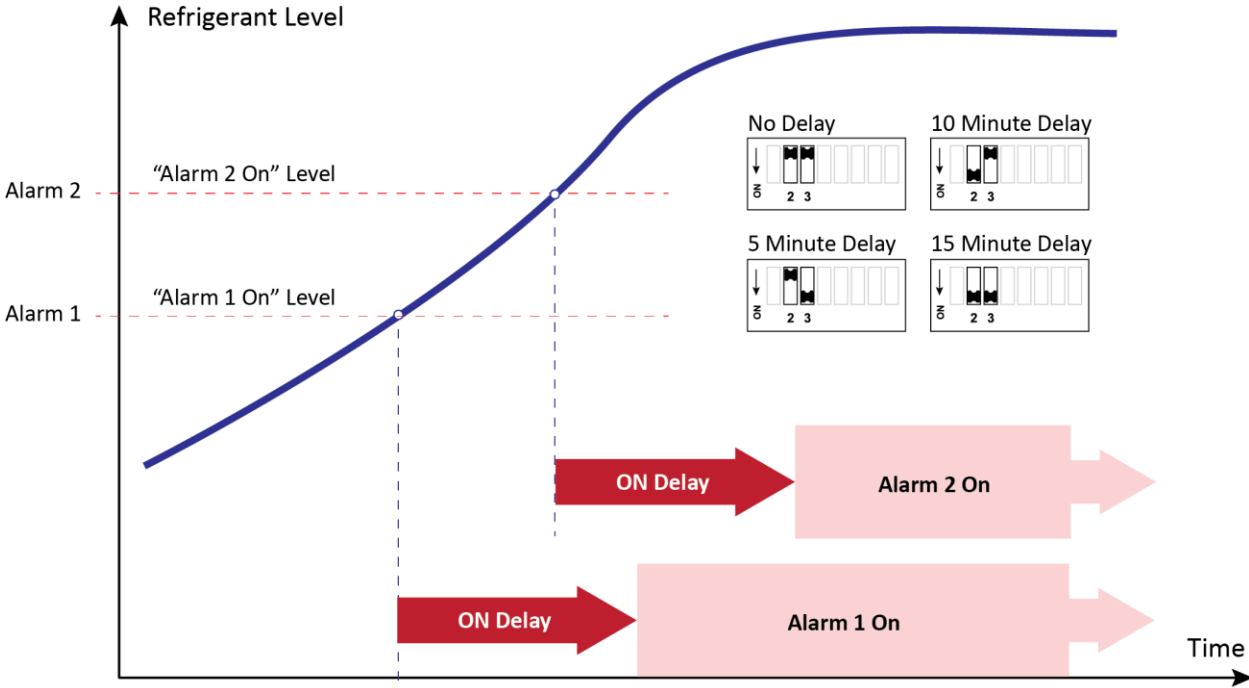

Figure 18. Alarm ON Delay for Multiple Alarm Levels

4.2.3 Failsafe – Switch 4

If ON, the relays will change state whenever either of the following occurs.

- Power loss
- Alarm condition.

4.2.4 Alarm 2 Relay – Switch 5

If ON, the relay will only change state as a result of an alarm condition. In the default configuration, Relay 2 will also indicate critical faults.

4.2.5 Latching Alarm State – Switch 6

If ON, the relay and Modbus flag will not change state until the concentration is below the alarm level and it is acknowledged. The acknowledgement can either happen by tapping and holding the magnetic wand for 5 seconds to the switch indicated as (●●) or by changing the respective Modbus flag to 0.

In the default configuration the alarms will automatically reset when the gas level is below the alarm thresholds.

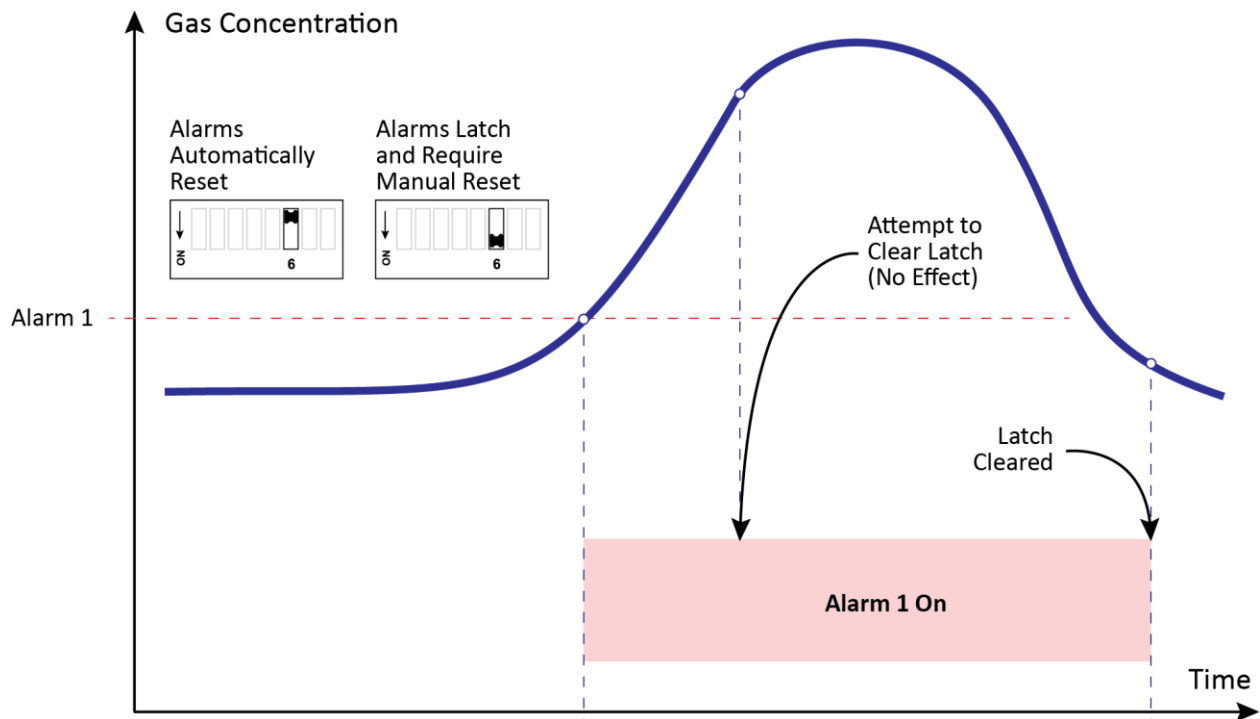

Figure 19. Latched Alarm Requiring Acknowledgement and Gas Concentration below Alarm Level

4.2.6 Buzzer Disable – Switch 7

If ON, the buzzer is disabled and will not sound.

4.3 Other Switch Configurations

4.3.1 Reset (Cycle Power) - Switch 1

Use the following procedure to cycle power to the MVR-300.

Step	Description
1.	Move switch 1 to the ON position.
2.	Move switch 1 to the OFF position.
3.	Power is cycled to the MVR-300.

4.3.2 Reset to Factory Default Values - Switch 8

Use the following procedure to reset all configurable Modbus registers to their factory default values.

Step	Description
1.	Ensure that the detector is off. If the detector is on, turn off power.
2.	Set switch 8 to ON.
3.	Turn on the detector. The buzzer will be ON and the LED will be OFF.
4.	Set switch 8 to OFF. The buzzer will be OFF and the LED will be OFF.
5.	Using the magnetic wand, hold magnetic switch 1 (●) for 60 seconds. LED is GREEN during this period.
6.	Wait for the LED to changes to ORANGE.
7.	Reset the detector by cycling power (by toggling switch 1).
8.	Detector will start-up as normal and re-read all switch settings.

4.4 Operation of Magnetic Switches, Buzzer, and LED

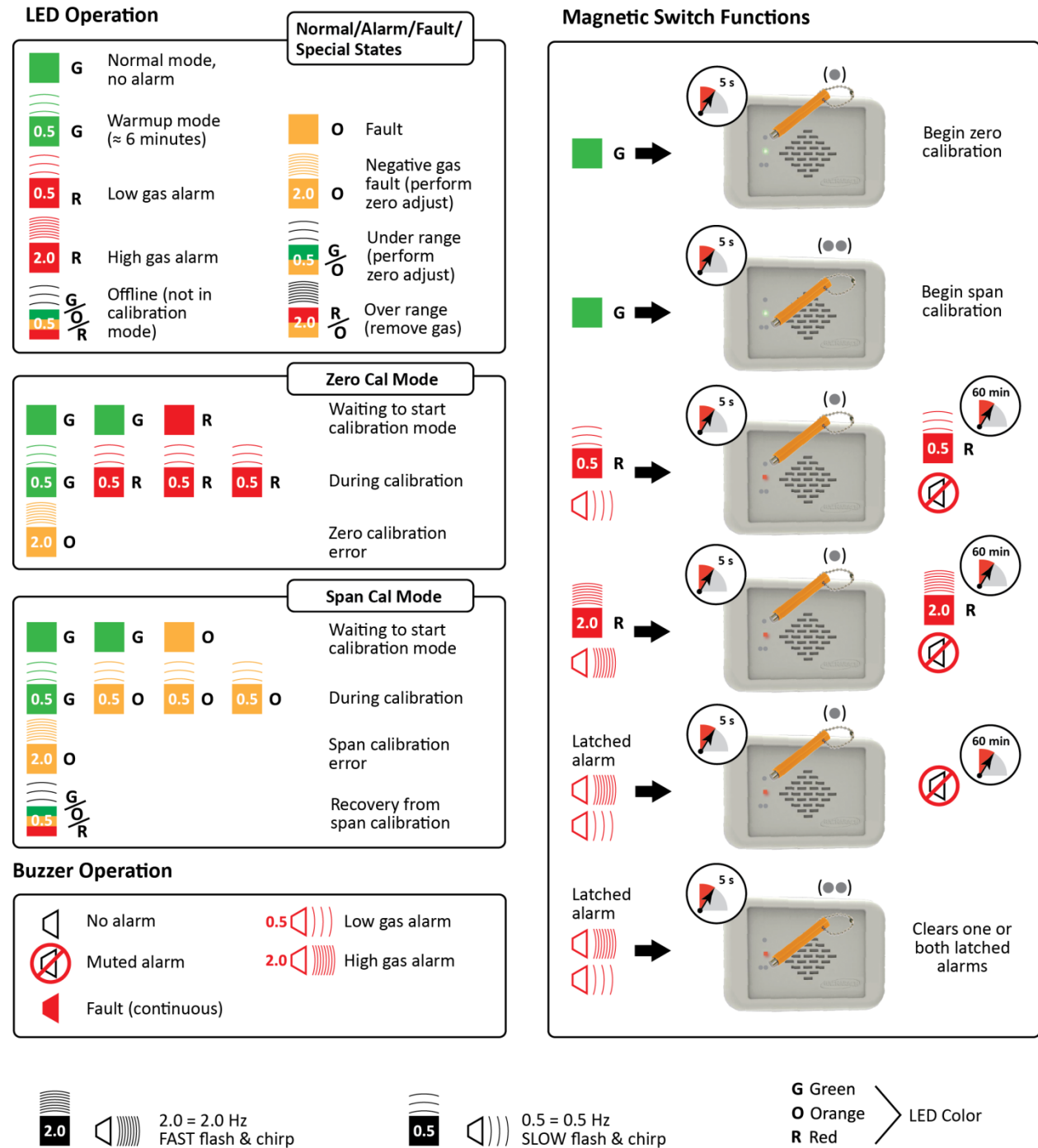

Figure 20. Operation of Magnetic Switches, Buzzer, and LED



If the drill pattern of the customized (metal) faceplate for the UK version of the MVR-300 does not accommodate the two magnetic switch locations, the faceplate must be removed to use the magnetic wand functions (e.g., zero adjustment, span adjustment, alarm latching, alarm silencing, etc.).

SECTION 5. MAINTENANCE

5.1 Maintenance Intervals

Interval	Function
During Commissioning	Check calibration.
	Check LEDs for proper operation.*
	Check for proper buzzer and relay operation.*
	Check signal transmission to the BMS/BAS (central controller) if connected.*
Every 6 Months	Inspection by trained service personnel.
	Check LEDs for proper operation.*
	Check for proper buzzer and relay operation.*
	Check signal transmission to the BMS/BAS (central controller) if connected.*
	Calibrate the sensor or contact Bacharach for sensor exchange with factory-calibrated sensor.
As Required	Replace sensor module(s) (see page 30).

* These can be activated via Modbus commands.

5.2 Adjustments

5.2.1 Introduction

Adjustment of the detector must be performed at regular intervals as required by national standards or regulations (e.g., EN 378, ASHRAE 15, BREEAM, etc.).



WARNING

Breathing Hazard: Calibration gas must not be inhaled! See appropriate Safety Data Sheets. Calibration gas should be vented into a fume hood or to the outside of the building.



WARNING

Zero First, Then Span: For proper operation, never adjust the span *before* completing a zero adjustment. Performing these operations out of order will cause faulty calibration.



WARNING

Bacharach recommends calibrating detectors within the application-specific condition and with target gas. This method of zeroing the detector in the application environment and performing a target gas calibration is more accurate. A surrogate gas calibration may only be performed as an alternative if a target gas calibration is not possible.



NOTICE

The sensor should be fully warmed-up (at least 2 hours, preferably 24 hours).



NOTICE

When entering the functions for zero or span adjustment, the detector will automatically enter OFFLINE mode, and will remain OFFLINE until either the OFFLINE mode is canceled by tapping the respective magnetic switch, or the OFFLINE mode times out within 6 minutes (typical) after the adjustment has ended.

MVR-300™ Refrigerant Gas Detector

5.2.2 General Procedure

Step	Description
1.	Verify that the detector is NOT in alarm and does not have a fault condition (i.e., it must <i>not</i> have a continuous orange LED).
2.	Verify that the calibration gas is in a balance of air, <u>not</u> Nitrogen (N ₂).
3.	Attach the pressure regulator to the calibration gas cylinder.
4.	Fit calibration adapter to the cover plate or base plate (see below).
5.	Connect the tubing to the barbed fittings of the pressure regulator and calibration adapter.
6.	Verify that gas flow is approximately 0.3 to 1.0 L/min.
7.	If operation is intended to be at higher altitudes, the factory calibration will result in a reading lower than the reading at sea level (reduced partial pressure). A new span adjustment is recommended if the altitude or the ambient pressure is changed. The factory calibration is set to sea level.
8.	Always perform a zero adjustment <i>before</i> a span adjustment.

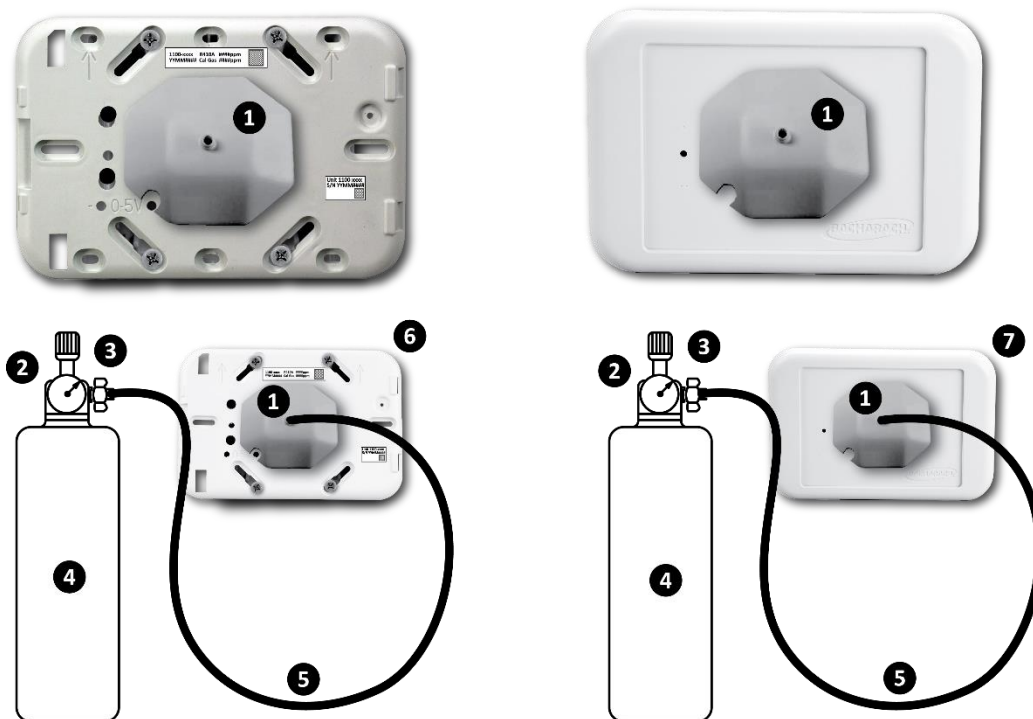

Item	Description of Calibration Components
1	Calibration adapter
2	Flow meter
3	Pressure regulator
4	Calibration gas
5	Tubing
6	Calibration from base plate (with test point access)
7	Calibration from cover plate

Figure 21. Calibration Assembly

5.2.3 Zero Adjustment

**WARNING**

Ambient air can be used to zero the sensor instead of synthetic air only if the area is known to be free of the target gas or any gas to which the sensor may be cross-sensitive. In this case, no cylinder or calibration adapter is needed for the zero adjustment.

Step	Description (Continued from General Procedure)
9.	Tap and hold (●) for more than 5 seconds. The LED will blink green-green-red to indicate the detector is ready.
10.	Apply synthetic air (or use ambient air per the warning above).
11.	Tap (●) within 30 seconds to confirm start of calibration. Otherwise the detector will time-out and return to normal operation.
12.	As the process progresses, the LED will blink green-red, green-red-red, green-red-red-red, etc. <ul style="list-style-type: none"> To abort calibration, tap and hold (●) for >5 seconds, turn off gas flow and remove the calibration adapter. The detector will return to normal operation. If calibration is successful (green LED), skip to step 15. If calibration is unsuccessful (orange LED blinks @ 2 Hz), then tap (●) to discard the calibration attempt, and see Section 5.3 on page 26 for troubleshooting.
13.	Turn off gas flow from synthetic air.
14.	Replace synthetic air tank with calibration gas tank in preparation for span adjustment.

5.2.4 Span Adjustment

Step	Description (Continued from Zero Adjustment)
15.	Tap and hold (●●) for >5 seconds. The LED will blink green-green-orange when the detector is ready.
16.	Apply span gas in the concentration listed on the cal gas concentration label (beneath the detector's cover plate). This may require the temporary removal of the bezel and cover plate to see the label.
17.	Tap (●●) within 30 seconds to confirm initiation of the calibration. Otherwise the detector will time-out and return to normal operation.
18.	As the calibration process progresses, the LED will blink green-orange, green-orange-orange, green-orange-orange-orange, etc. <ul style="list-style-type: none"> To abort calibration, tap and hold (●●) for >5 seconds, turn off gas flow and remove the calibration adapter. The detector will return to normal operation. If calibration is successful, the LED will blink green-orange-red indicating 'offline'. Turn off gas flow and remove the calibration adapter. After 6 minutes the detector will return to normal operation. If calibration is unsuccessful (orange LED blinks @ 2 Hz), then tap (●●) to discard the calibration attempt, and see Section 5.3 on page 26 for troubleshooting. Turn off gas flow and remove the calibration adapter. After 6 minutes the detector will return to normal operation.

MVR-300™ Refrigerant Gas Detector

5.2.5 Bump Test

A bump test is a live test of a system to verify that the detector responds to gas and all connected alarm devices, BMS, etc. are operating accordingly. In this case it is necessary that all involved persons are informed about the test and certain alarms might have to be inhibited (e.g., shutdown valves, notification of authorities, etc.).

Step	Description
1.	Inform building personnel of test so that certain alarms may be inhibited (e.g., shutdown valves, notification of authorities, etc.).
2.	Connect adapter and target gas according to instructions in Section 5.2.2: General Calibration Procedure on page 24.
3.	Apply a sufficiently high concentration of target gas to trigger alarms, but not pure refrigerant or hydrocarbons (e.g., do not use a butane lighter), as this might damage the sensor.
4.	Once the alarm thresholds are exceeded, all designated gas alarm relays will be activated and the digital outputs will transmit the corresponding gas concentrations.
5.	Turn off gas flow and remove calibration adapter.

5.3 Troubleshooting

5.3.1 Failed Span Adjustment

Step	Description
1.	Remove bezel and face plate.
2.	Attach calibration adapter.
3.	Configure voltmeter to measure 0 to 5 VDC.
4.	Insert voltmeter probes into the marked test points.
5.	Tap and hold (●●) for more than 5 seconds.
6.	The LED will blink green-green-orange to indicate the detector is ready.
7.	Apply span gas in the concentration listed on the cal gas concentration label on the detector base.
8.	Tap (●●) within 30 seconds confirm to initiate calibration. Otherwise the detector will time-out and return to normal operation.
9.	While gas is being applied the analog output will generate a voltage proportional to the measured gas concentration. For example, for a 5,000 ppm span detector, applying 2,500 ppm cal gas should, once stable, result in a 2.5 VDC reading. $\text{Reading} = 5 \times \frac{2500}{5000} = 2.5 \text{ VDC}$
10.	As the process progresses, the LED will blink green-orange, green-orange-orange, green-orange-orange-orange, etc.
11.	To abort the calibration tap and hold (●●) for more than 5 seconds.
12.	The LED will blink green-orange-red indicating "offline".
13.	Turn off gas flow and remove the calibration adapter from the detector.
14.	The detector will return after 6 minutes (typical) to normal operation.
15.	If the calibration was successful, skip the next step.
16.	If the calibration was not successful, the orange LED will blink at 2 Hz.
17.	Tap (●●) to discard the calibration attempt.

Step	Description
18.	The voltage reading is an indicator of the sensitivity of the sensor. If the voltage reading is significantly lower than the expected value, the sensor module must be replaced.
19.	The LED will blink green-orange-red indicating “offline”.
20.	Turn off gas flow and remove the calibration adapter from the detector.
21.	Put cover plate back on and tighten set screw.
22.	Put bezel back on.
23.	The detector will return to normal operation after 6 minutes (typical).

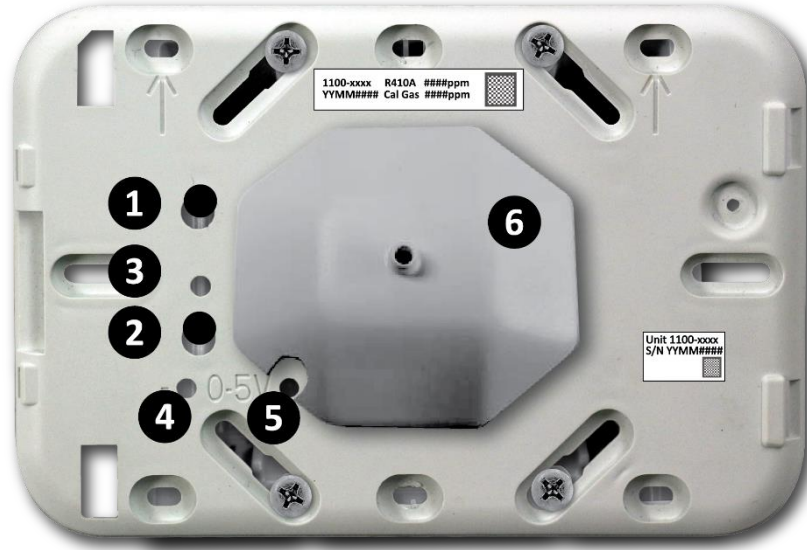

Item	Description
1	Magnetic switch position 1 (●)
2	Magnetic switch position 2 (●●)
3	Multi-color status LED
4	0-5 V test point access hole (-)
5	0-5 V test point access hole (+)
6	Calibration adapter

Figure 22. Test Point Access with Calibration Adapter in Place

5.3.2 Hexadecimal Format

All fault codes can be retrieved through the Modbus interface and are shown in hexadecimal (hex) format. A hex digit can represent multiple codes as shown below.

Hex Code	Equivalent Error Code(s)	Hex Code	Equivalent Error Code(s)	Hex Code	Equivalent Error Code(s)	Hex Code	Equivalent Error Code(s)
0	0	4	4	8	8	C	4 + 8
1	1	5	1 + 4	9	1 + 8	D	1 + 4 + 8
2	2	6	1 + 2 + 3	A	2 + 8	E	2 + 4 + 8
3	1 + 2	7	1 + 2 + 4	B	1 + 2 + 8	F	1 + 2 + 4 + 8

MVR-300™ Refrigerant Gas Detector

5.3.3 Fault Conditions

Bit Mask (HEX)	Fault	Description	Fault State	Priority	Clearing Action	Required Actions During Fault
All bits cleared	No fault					
0x0001	Software fault	Firmware error (e.g., unexpected switch state)	Fatal fault	1	Acknowledge (reset firmware)	Wait for switch 2 hold
0x0002	Sensor out	Cannot detect sensor	Critical fault	2	Sensor Detected	Check sensor
0x0004	Input voltage fault	Power supply voltage out of range.	Critical fault	2	Input voltage within specification	Check Input voltage
0x0008	Memory fault	Error in reading/writing to RAM, flash or internal (PIC) EEPROM	Critical fault	2	Memory test passed	Test memory
0x0010	DAC fault	Error updating DAC value	Non critical fault	4	DAC can be written to	Write to DAC
0x0020	Stuck magnetic switch	Magnetic switch activated for > 1 minute	Non critical fault	4	Switch released	Check switch state
0x0040	Negative gas concentration fault	Sensor output has drifted too negative	Negative gas fault	3	Gas concentration exceeds negative gas limit	Check gas concentration
0x0080	Invalid calibration	Error in calibration configuration	Critical fault	2	Load valid calibration	Read from external EEPROM
0x0100	Zero calibration failure	Zero calibration failed	Calibration failure	5	Acknowledgement of failed calibration	Wait for switch 2 hold
0x0200	Sensor read EEPROM fault	Error in reading from external EEPROM	Critical fault	2	External EEPROM read success	Read from external EEPROM
0x0400	Sensor write EEPROM fault	Error in reading writing to external EEPROM	Critical fault	2	External EEPROM write success	Wait for write
0x0800	Sensor configuration fault	Error in external EEPROM data	Critical fault	2	External EEPROM write valid data	Wait for write
0x1000	Span calibration failure	Span calibration failed	Calibration failure	5	Acknowledgement of failed calibration	Wait for switch 2 hold
0x2000	System read EEPROM fault	Error in reading from internal EEPROM	Critical fault	2	Internal EEPROM read/write success	Read from internal EEPROM
0x4000	System write EEPROM fault	Error in reading writing to internal EEPROM	Critical fault	2	Internal EEPROM read/write success	Wait for write
0x1000	System configuration fault	Error in internal EEPROM data	Critical fault	2	Internal EEPROM write valid data	Wait for write

5.3.4 Fatal Faults

- Orange LED is on
- Relay 2 indicates fault, if configured
- Buzzer is on
- Modbus flag is set to fault
- Gas reading is invalid

Fatal faults can only be recovered by rebooting the system. To reboot the system do the following.

Step	Description
1.	Tap and hold (●●) for more than 5 seconds or set the Modbus flag.
2.	If the reboot was successful, the detector will return to normal operation. Otherwise exchange detector.

5.3.5 Critical Faults

- Orange LED is on
- Relay 2 indicates fault, if configured
- Buzzer is on
- Modbus flag is set to fault
- Gas reading is invalid

Step	Description
1.	If the remedy suggestions are successful or the detector can resolve the issue, the critical fault is canceled and the detector returns to normal operation.
2.	If the detector is set to latching, tap and hold (●●) to acknowledge the latch mode or set the Modbus flag.

5.3.6 Negative Gas Fault

- Orange LED blinks at frequency of 2 Hz
- Relay 2 indicates fault, if configured
- Buzzer is on
- Modbus flag is set to fault
- Gas reading is invalid

The zero point of the sensor has drifted below the acceptable limit. This could be intermittent if the zero reading is chattering around the limit.

Step	Description
1.	Hold (●●) for 5 seconds to acknowledge a negative gas fault.
2.	If the fault is still active the detector begins the Zero Calibration process; otherwise the fault may clear.
3.	If a zero calibration is not possible exchange the sensor.

5.3.7 Non-Critical Faults

- Orange LED is on
- Modbus flag is set to fault
- Gas reading and alarm management is valid

The detector is fully functional, however, this condition needs to be resolved.

5.4 Replacing the Sensor Module



This product uses semiconductors which can be damaged by electrostatic discharge (ESD). When handling the PCB, care must be taken so that the electronics is not damaged.

CAUTION

Step	Description
1.	Power-down detector.
2.	Remove bezel and cover plate.
3.	Pull out sensor module. It is recommended to use extractor tool part number 1100-2022.
4.	Plug new sensor module into sensor control PCB. Ensure that the three notches of the sensor module align with the 3 ribs of the detector base. Use the small triangles printed on the sensor module as a guide.
5.	Put cover plate back on and tighten set screw.
6.	Put bezel back on and power-up detector.
7.	Wait until the start-up sequence is finished.
8.	Check sensor response.

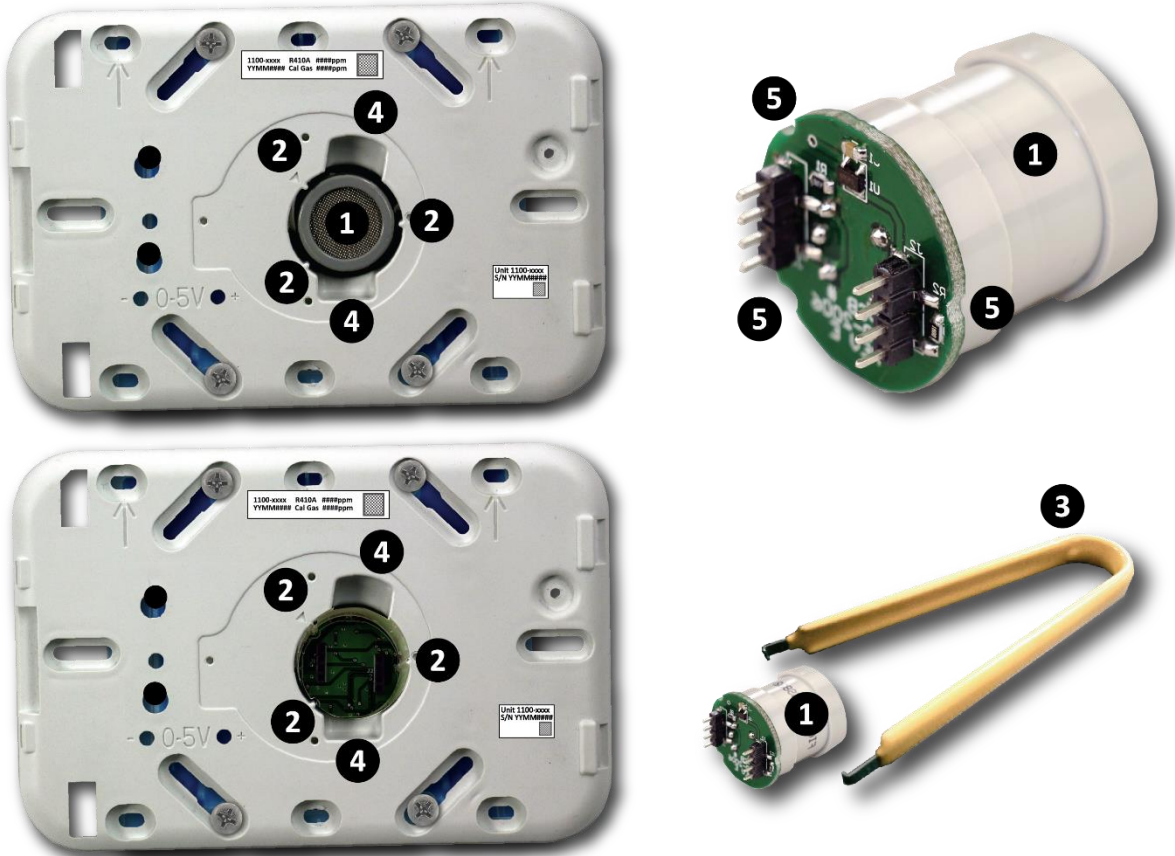

Item	Description
1	Replaceable sensor module
2	Sensor alignment ribs (x3)
3	Sensor extractor tool (color may vary)
4	Recesses (x2) for extracting sensor
5	Alignment notches (x3) on sensor module

Figure 23. Sensor Replacement Showing Sensor Extractor Tool

5.5 Cleaning the Detector

Clean the detector with a soft cloth using water and a mild detergent. Rinse with water. Do not use any alcohols, cleaning agents, sprays, polishes, detergents, etc.

SECTION 6. SENSOR PRINCIPLE

Semiconductor or metallic oxide sensors (MOSs) are among the most versatile of all broad-range sensors. They are heated to a temperature between 150° and 300° C depending on the gas(es) to be detected. The temperature of operation as well as the “recipe” of mixed oxides determines the sensor selectivity to various refrigerants. Electrical conductivity greatly increases as soon as a diffusion process allows the refrigerant molecules to come in contact with the sensor surface. Water vapor, high ambient humidity, temperature fluctuations, alcohols, cleaning agents, sprays, polishes, detergents, and low oxygen levels can result in higher readings.



NOTICE

Certain substances in the environment may impair the sensitivity of the sensors:

1. Materials containing silicone or silicone rubber/putty
 2. Corrosive gases such as hydrogen sulfide, sulfur oxide, chlorine, hydrogen chloride, etc.
 3. Alkaline metals, salt water spray.
-

SECTION 7. DISPOSING OF THE DETECTOR



EU-wide regulations governing the disposal of electrical and electronic appliances which have been defined in the EU Directive 2012/19/EU and in national laws have been effective since August 2012 and apply to this device.

Common household appliances can be disposed of using special collecting and recycling facilities. However, this device has not been registered for household usage. Therefore it must not be disposed of through these channels. The device can be returned to your national Bacharach Sales Organization for disposal. Contact Bacharach if you have any questions.

SECTION 8. TECHNICAL DATA

8.1 Approvals

Specification	Description
EN 50270:2015	Electromagnetic compatibility. Electrical apparatus for the detection and measurement of combustible gases, toxic gases or oxygen
CE	Approval pending
UL/CSA/IEC/EN 61010-1	Approval Pending

8.2 Specifications for Modbus RTU Digital Communication over RS-485

Specification	Description
Baud Rate	9,600 ¹ or 19,200 (selectable)
Start Bits	1
Data Bits	8
Parity	None ¹ , odd, even (selectable)
Stop Bits	1 ¹ or 2 (selectable)
Retry Time	500 ms, min time between retries
End of Message	Silent 3.5 characters

¹ - Default Values

8.3 Power Supply and Relay Specifications

Specification	Description
Operating Voltage	100 to 240 VAC, 50/60 Hz
Operating Power	4 W max
Power Monitoring	Green LED
Relay Rating	2 SPDT; 1 A at 30 VDC, 1 A at 125 and 250 VAC, resistive load
Audible Alarm	Internal Buzzer; open enclosure 85 dBA at 10 cm (4 in); 80 dBA @ 30 cm (12 in)
Alarm Delay	0 to 15 minutes (selectable 0, 5, 10, 15)

8.4 Wiring Specifications

Specification	Description
Power	3-core cable, 14 to 20 AWG
Relay	3-core cable, 18 to 20 AWG
Modbus Network	Belden 3106A (or equivalent); 3-core, 2 twisted pair shielded cable 20 to 26 AWG with 120 Ω characteristic impedance Max diameter of cable plus heat shrink must be \leq 5 mm (0.2 in) (to fit boot)

8.5 Physical Specifications

Specification	Description
Enclosure Material	ABS
Enclosure Protection	IP40, NEMA 1
Size L x W x D (Approximate)	5.98 x 4.68 x 1.96". (152 x 119 x 50 mm) including bezel Depth of bezel 0.39" (10 mm)
Weight (Approximate)	8 oz (230 g)

8.6 Environmental Specifications

Specification	Description
Temperature	32° to 122° F (0° to 50° C)
Storage Temperature	-40° to 122° F (-40° to 50° C)
Humidity	5 to 90% RH, non-condensing
Pressure	23.6 to 32.5 in. of Hg (800 to 1100 hPa)
Elevation	0 to 6,560 ft. (2000 m) altitude

8.7 Sensor Specifications

Specification	Description
Detectable Gases	R-22, R-32, R-404a, R-407c, R-410a
Measuring Ranges	0 to 2,500 ppm; 0 to 5,000 ppm; 0 to 10,000 ppm

8.8 Default Alarm Levels

Alarm #	Alarm Ranges		
	0 to 2,500 ppm	0 to 5,000 ppm	0 to 10,000 ppm
Alarm 1	500 ppm	1,000 ppm	2,000 ppm
Alarm 2	2,000 ppm	4,000 ppm	8,000 ppm

8.9 Modbus Registers



If items span two registers (e.g., 1005 and 1006), then the registers are “long” or “float” data types. Otherwise the registers are integer data types or ASCII.

NOTICE

8.9.1 Read Device Identification

The following Object IDs are used with function code 43/14 to read ASCII device identification objects.

Object ID	Name	Description	Def Val
0x00	Read Device Identification	Vendor name	"Bacharach"
0x01	Read Device Identification	Product code	"MVR-300"
0x02	Read Device Identification	Revision (Major/minor/"bug fix")	"NN.nn.bb"

8.9.2 Analog Input Registers

Analog input registers are read only and use function code 04.

Reg Addr	Name	Description	Data Type	Def Val
1000	16 bit Current Fault Code	Active or latched faults	Hex	0
1001	16 bit Last Fault Code	All faults which have occurred since startup or fault register reset	Hex	0
1002	Gas Concentration PPM	Current gas concentration in PPM	Unsigned Integer	
1003	Gas Concentration % FS (0-100)	Current gas concentration as percentage of full scale	Unsigned Integer	
1004	Hours since last calibration	Can be reset by a calibration operation	Unsigned Integer	
1005	PPM Hours	Sensor gas exposure clock. Cannot be reset	32-bit long	
1006				
1012	Software Version Sensor Major	Software Version in the format NN.nn.bb.	Unsigned Integer	
1013	Software Version Sensor Minor		Unsigned Integer	
1014	Software Version Sensor Bug Fix		Unsigned Integer	
1015	Sensor Type Code	Hex code indicating the sensor type, gas and range	Hex	
1016	Full Scale in PPM	Limit of measurement of the sensor	Unsigned Integer	
1017	Gas Low Alarm PPM	Low alarm threshold in PPM	Unsigned Integer	
1018	Gas High Alarm PPM	High alarm threshold in PPM	Unsigned Integer	

MVR-300™ Refrigerant Gas Detector

Reg Addr	Name	Description	Data Type	Def Val
1019	Gas Low Alarm % FS (0-100)	Low alarm threshold as percentage of full scale	Unsigned Integer	
1020	Gas High Alarm % FS (0-100)	High alarm threshold as percentage of full scale	Unsigned Integer	
1021	Minimum Alarm Setting PPM	Lowest allowable alarm setting	Unsigned integer	
1022	Sensor Gas Type Text Char 1,2	Text string indicating the target gas e.g., "R410a"	ASCII	
1023	Sensor Gas Type Text Char 3,4		ASCII	
1024	Sensor Gas Type Text Char 5,NULL		ASCII	
1025	Main Electronics UID Char 1,2	Text string indicating the detector serial number e.g., "U1234567"	ASCII	
1026	Main Electronics UID Char 3,4		ASCII	
1027	Main Electronics UID Char 5,6		ASCII	
1028	Main Electronics UID Char 7,8		ASCII	
1029	Sensor Module SID Char 1,2	Text string indicating the sensor serial number e.g., "S7654321"	ASCII	
1030	Sensor Module SID Char 3,4		ASCII	
1031	Sensor Module SID Char 5,6		ASCII	
1032	Sensor Module SID Char 7,8		ASCII	
1036	Signed Raw Gas Concentration PPM - no thresholding	Raw gas concentration used for calibration procedure	Signed integer	
1037	Rate of change of sensor resistance	Rate of change of semiconductor sensor resistance. Used to determine stability of gas response in calibration	Float	
1038				
1039	Sensor cal gas lower limit PPM	Lower limit of the gas for calibration	Unsigned Integer	
1040	Sensor cal gas upper limit PPM	Upper limit of the gas for calibration	Unsigned Integer	
1041	Auto Cal Zero Time Remaining	Seconds remaining in auto zero calibration procedure	Unsigned Integer	0
1042	Auto Cal Span Time Remaining	Seconds remaining in auto span calibration procedure	Unsigned Integer	0
1043	Auto Cal Recovery Time Remaining	Seconds remaining in span recovery	Unsigned Integer	0

8.9.3 Analog Output Registers

Analog output registers are readable (using function code 03) and writable (using function code 06).



Before writing to any “locked” registers, be sure to use the Parameter Unlock register (2000) first to unlock the registers and (if desired) to re-lock those registers afterwards.

NOTICE

Reg Addr	Name	Description	Data Type	Def Val	R/W
2000	Parameter Unlock	Writing the correct unlock code (0x6388) to this register allows an external controller to change system parameters. Writing any other value (or cycling power thereby restoring the default value of zero) re-locks the lockable system parameters.	Unsigned integer	0	R/W
2001	RS-485 Node Address	Modbus address 1-247	Unsigned integer	1	R/W
2002	Baud Rate	0 = 9600 Baud; 1 = 19200 Baud	Unsigned integer	0 (9600 baud)	R/W
2003	Stop Bits	Number of stop bits	Unsigned integer	1	R/W
2004	Parity	Parity (0=none, 1=odd, 2=even)	Unsigned integer	None	R/W
2005	Gas Low Alarm PPM	Low gas alarm in PPM	Unsigned integer	Unit dependent	R. W if un-locked
2006	Gas High Alarm PPM	High gas alarm in PPM	Unsigned integer	Unit dependent	R. W if un-locked
2007	Modbus Precedence over DIP Switch Settings	If set then the values programmed over Modbus take precedence over the values set by DIP switch 0 = DIP settings used 1 = MODBUS settings used	Unsigned integer	0	R. W if un-locked
2008	Alarm On Delay Value	Alarm On delay in minutes. Range 0-15. Note: Setting only has an effect if the Modbus priority flag is set	Unsigned integer	0	R. W if un-locked
2009	Relay Contact Behavior / Failsafe	0 = NO relay 1 = Failsafe relay Note: Setting only has an effect if the Modbus priority flag is set	Unsigned integer	0	R. W if un-locked

MVR-300™ Refrigerant Gas Detector

Reg Addr	Name	Description	Data Type	Def Val	R/W
2010	Relay 2 Fault Indication	0 = Relay 2 indicates high alarm only 1 = Relay 2 indicates high alarm and fault condition Note: Setting only has an effect if the Modbus priority flag is set	Unsigned integer	0	R. W if un-locked
2011	Alarm Latching Behavior	0 = Alarms automatically reset 1 = Alarms must be acknowledged Note: Setting only has an effect if the Modbus priority flag is set	Unsigned integer	0	R. W if un-locked
2012	Buzzer disable	0 = Buzzer normal operation 1 = Buzzer disabled Note: Setting only has an effect if the Modbus priority flag is set	Unsigned integer	0	R. W if un-locked
2017	Calibration Gas Level PPM	Level of gas being applied during calibration	Unsigned integer	Unit dependent	R. W if un-locked

8.9.4 Input Status Flags

Input status flags are readable (using function code 02).

Reg Addr	Name	Description	Data Type	Def Val
3000	Gas Low Alarm Flag	0 = No low alarm state 1 = Low alarm active or latched	Boolean	0
3001	Gas High Alarm Flag	0 = No high alarm state 1 = Low alarm active or latched	Boolean	0
3002	Saturation Overflow	0 = Gas level less than or equal to full scale range 1 = Gas level exceeds full scale range	Boolean	0
3003	Saturation Underflow	0 = Gas level greater than or equal to 0 ppm 1 = Gas level underflow condition	Boolean	0
3004	Startup	Detector is in startup. No valid gas level or outputs	Boolean	0
3005	Detector Offline	Detector not reporting gas level or generating alarm conditions	Boolean	0
3006	Detector Fault	The detector is reporting a fault which prevents valid gas level or output generation	Boolean	0
3007	Relay 1 State	0 = Relay de-energized 1 = Relay energized	Boolean	0
3008	Relay 2 State	0 = Relay de-energized 1 = Relay energized	Boolean	0

8.9.5 Output Status Flags

Output status flags are readable (using function code 01) and writable (using function code 05).



NOTICE

Before writing to any “locked” registers, be sure to use the Parameter Unlock register (2000) first to unlock the registers and (if desired) to re-lock those registers afterwards.

Reg Addr	Name	Description	Data Type	Def Val	R/W
4000	Offline mode	Setting this flag places the detector into offline mode. When offline the detector will not respond to gas events or generate alarm conditions. The flag will remain asserted for the duration of offline mode. Offline mode will end after expiry of the offline mode timeout or by clearing this flag.	Boolean	0	R. W if un-locked
4001	Calibration expired	1 => The sensor requires calibration Can be cleared by performing a calibration or by resetting this flag.	Boolean	0	R. W if un-locked
4002	Start Zero Calibration Procedure	Setting this flag triggers the automatic zero calibration procedure. The flag will remain asserted during the procedure. Writing a zero to the flag during the procedure will cancel the procedure and the detector will return to normal operation.	Boolean	0	R. W if un-locked
4003	Start Span Calibration Procedure	Setting this flag places the detector offline and triggers the automatic span calibration procedure. The flag will remain asserted during the procedure. Writing a zero to the flag during the procedure will cancel the procedure and the detector will remain offline for the duration of the span calibration recovery time.	Boolean	0	R. W if un-locked
4004	Perform Immediate Zero Calibration Procedure	Setting this flag performs an immediate zero calibration. The detector will return to normal operation on completion.	Boolean	0	R. W if un-locked
4005	Perform Immediate Span Calibration Procedure	Setting this flag performs an immediate span calibration as long as the detector is already in offline mode. The detector will remain offline for the duration of the span calibration recovery time after completion of the procedure	Boolean	0	R. W if un-locked
4006	Alarm Flag	If asserted then a gas alarm state exists. Clearing this flag will clear any latched alarm states.	Boolean	0	R. W if un-locked
4007	Clear last fault	Clear non-active faults from LAST FAULT register. If any current faults are still active then these will be held in LAST FAULT register.	Boolean	0	R. W if un-locked

MVR-300™ Refrigerant Gas Detector

Reg Addr	Name	Description	Data Type	Def Val	R/W
4013	Manual Override	Setting this flag places the detector into manual override mode to allow for testing of outputs. During manual override mode the relays, analog output and LEDs will not respond to gas events, alarm conditions or faults. Manual override mode may be terminated by clearing this flag. Alternatively the mode will timeout after a set period after which normal operation will resume.	Boolean	0	R. W if un-locked
4014	Relay 1 Manual Control	If the detector is in manual override mode, setting this flag energizes relay 1; clearing this flag de-energizes relay 1. Relay failsafe configuration has no effect on this test.	Boolean	0	R. W if un-locked
4015	Relay 2 Manual Control	If the detector is in manual override mode, setting this flag energizes relay 2; clearing this flag de-energizes relay 2. Relay failsafe configuration has no effect on this test.	Boolean	0	R. W if un-locked
4016	Buzzer Test Mode	If the detector is in manual override mode, setting this flag activates the buzzer; clearing this flag deactivates the buzzer. Buzzer mute control has no effect on this test.	Boolean	0	R. W if un-locked
4017	Red LED Manual Control	If the detector is in manual override mode, setting this flag turns on the red LED; clearing this flag turns off the red LED.	Boolean	0	R. W if un-locked
4018	Green LED Manual Control	If the detector is in manual override mode, setting this flag turns on the green LED; clearing this flag turns off the green LED.	Boolean	0	R. W if un-locked
4019	Analog Output Manual Control	If the detector is in manual override mode, setting this flag sets the analog output to full scale; clearing this flag sets the analog output to zero.	Boolean	0	R. W if un-locked

SECTION 9. ORDERING INFORMATION

9.1 MVR-300 Refrigerant Leak Detector Configurations

P/N	Detection Range	Refrigerant
6203-0001	0 to 2500 ppm	R-410a
6203-0002	0 to 5000 ppm	
6203-0003	0 to 10000 ppm	
6203-0011	0 to 2500 ppm	R-407c
6203-0012	0 to 5000 ppm	
6203-0013	0 to 10000 ppm	
6203-0021	0 to 2500 ppm	R-404a
6203-0022	0 to 5000 ppm	
6203-0023	0 to 10000 ppm	
6203-0041	0 to 2500 ppm	R-32
6203-0042	0 to 5000 ppm	
6203-0043	0 to 10000 ppm	

9.2 MVR-300 Refrigerant Leak Detector Configurations (UK Version)

P/N	Detection Range	Refrigerant
6203-1001	0 to 2500 ppm	R-410a
6203-1002	0 to 5000 ppm	
6203-1003	0 to 10000 ppm	
6203-1011	0 to 2500 ppm	R-407c
6203-1012	0 to 5000 ppm	
6203-1013	0 to 10000 ppm	
6203-1021	0 to 2500 ppm	R-404a
6203-1022	0 to 5000 ppm	
6203-1023	0 to 10000 ppm	
6203-1041	0 to 2500 ppm	R-32
6203-1042	0 to 5000 ppm	
6203-1043	0 to 10000 ppm	

9.3 Accessories

P/N	Description		Std	UK	
0051-2320	Pressure Regulator (1.0 l/min, 5/8"-18 UNF)		✓	✓	
0051-2358	Pressure Regulator (0.5 l/min, 5/8"-18 UNF)		✓	✓	
0051-3299	Pressure Regulator (0.3 l/min, 5/8"-18 UNF)		✓	✓	
1100-1004	Magnetic Wand		✓	✓	
1100-2018	Calibration Kit (Standard Version), includes: <ul style="list-style-type: none"> • MVR-300 Calibration Adapter, Standard Version (1100-2017) • DIP Extractor Tool (1100-2022) • Magnetic Wand (1100-1004) • Tubing for Calibrating Kit, Reactive Gases (1000-3718) 		✓		
1100-2045	Calibration Kit (UK Version), includes: <ul style="list-style-type: none"> • MVR-300 Calibration Adapter, UK Version (1100-2056) • DIP Extractor Tool (1100-2022) • Magnetic Wand (1100-1004) • Tubing for Calibrating Kit, Reactive Gases (1000-3718) 			✓	
1100-2022	Extractor Tool (for removing sensor module during replacement process)		✓	✓	
1100-2043	MVR-300 Standard Version, Replacement Plastics Kit, includes: <ul style="list-style-type: none"> • Top Cover, Plastic (1100-2008) • Bottom Cover, Plastic (1100-2009) • Bezel, Plastic (1100-2010) • Faceplate, Bacharach Logo, Plastic (1100-2011) • Assembly Screws (1100-2026) • Faceplate Screw (1100-2027) • Light Pipe (1100-2038) • Standard Installation Kit, Standard Version (1100-2036), includes: <ul style="list-style-type: none"> ○ Rubber Boot (1100-2025) ○ Heat Shrink Tubing (1100-2028) 		✓		
1100-2044	MVR-300 UK Version, Replacement Plastics Kit, includes: <ul style="list-style-type: none"> • Top Cover, UK Flush-mount, Plastic (1100-2023) • Bottom Cover, Plastic (1100-2009) • Assembly Screws (1100-2026) • Light Pipe (1100-2038) • Installation Kit, UK Version (1100-2037), includes: <ul style="list-style-type: none"> ○ Rubber Boot (1100-2025) ○ Heat Shrink Tubing (1100-2028) ○ Mounting Clips, Qty 2 (1100-2039) ○ Mounting Clip Screws, Qty 2 (1100-2039) 			✓	
6203-0101	Calibrated Sensor Assembly	0 to 2500 ppm	R-410a	✓	✓
6203-0102	Calibrated Sensor Assembly	0 to 5000 ppm		✓	✓
6203-0103	Calibrated Sensor Assembly	0 to 10000 ppm		✓	✓
6203-0111	Calibrated Sensor Assembly	0 to 2500 ppm	R-407c	✓	✓
6203-0112	Calibrated Sensor Assembly	0 to 5000 ppm		✓	✓
6203-0113	Calibrated Sensor Assembly	0 to 10000 ppm		✓	✓
6203-0121	Calibrated Sensor Assembly	0 to 2500 ppm	R-404a	✓	✓
6203-0122	Calibrated Sensor Assembly	0 to 5000 ppm		✓	✓
6203-0123	Calibrated Sensor Assembly	0 to 10000 ppm		✓	✓
6203-0141	Calibrated Sensor Assembly	0 to 2500 ppm	R-32	✓	✓
6203-0142	Calibrated Sensor Assembly	0 to 5000 ppm		✓	✓
6203-0143	Calibrated Sensor Assembly	0 to 10000 ppm		✓	✓
On Request	Calibration Gas Cylinder			✓	✓

SECTION 10. CUSTOM UK BACK BOXES AND FACEPLATES

10.1 Introduction to UK Version

The standard MVR-300 supports various back boxes as outlined earlier. A custom United Kingdom version of the MVR-300 has a slightly different mounting profile to support a unique non-standard mounting method of the typical UK back box. This version requires the use of a customized faceplate not supplied by Bacharach. This section explains the differences associated with installing and using the UK version of the MVR-300.



NOTICE

Functionally, the standard and UK versions of the MVR-300 are identical, but mechanical installation is slightly different. The UK version has a unique detector base plate (suitable for the UK back box) and requires a customized cover plate. Electrical wiring of the UK version is identical to the standard version, but requires additional grounding to accommodate custom metal faceplates.



Figure 24. UK Version of MVR-300 and Representative UK Back Box

10.2 Hardware Overview – UK Version

Most UK back boxes have mounting tabs of two different heights. The UK version of the MVR-300 accommodates both through the use of thicker, molded plastic mounting tabs, and optional thinner metal tabs. In applications requiring the thinner metal tabs, the standard plastic tabs must first be removed.

If the tabs of your back box are too high, the MVR-300 may protrude too far from wall. In this case, you will need to remove the plastic tabs from MVR-300 base plate and replace them with thinner metal tabs (provided) to permit proper flush mounting. This procedure is explained in detail in the next section.



CAUTION

Extreme care must be exercised when removing the plastic tabs to avoid damaging the base plate. Before permanently removing the thicker plastic tabs, be sure to dry fit the assembly using the plastic tabs first in order to verify that your UK back box requires the thinner metal tabs for proper flush mounting. Only then should the plastic tabs be removed from the base plate. Refer to the next section for detailed instructions.

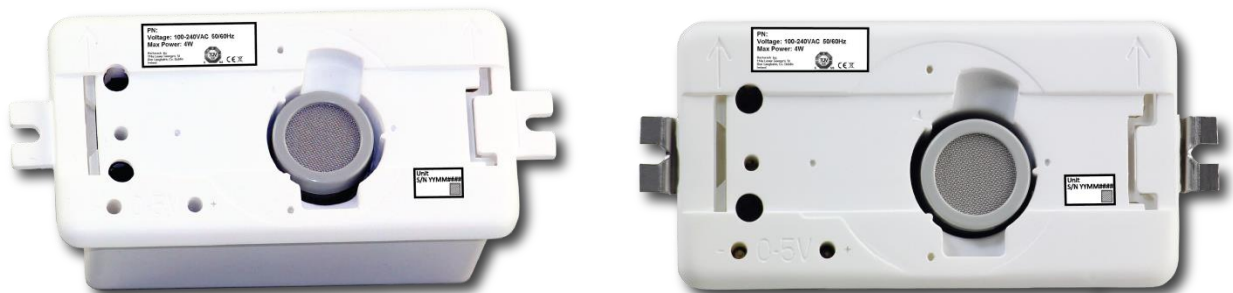



Figure 25. UK Base Plate with Plastic Tabs and Optional Thinner Metal Tabs

10.3 Using Optional Metal Tabs



Follow the instructions in this section **ONLY** after (1) dry fitting the MVR-300 using the plastic tabs, and (2) determining that the plastic tabs are too thick for the UK back box you are using (resulting in a gap between the wall and the custom faceplate).

After you determine that the plastic tabs on your base plate need to be replaced with the thinner metal tabs for proper flush mounting in your application, then follow the steps below.

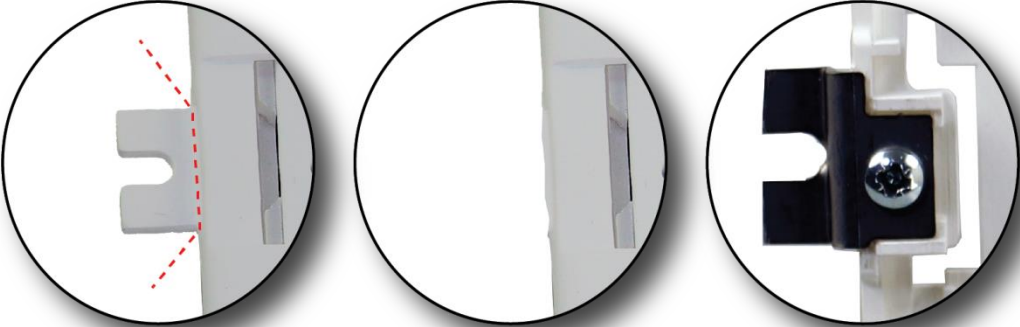
Step	Installation of Optional Metal Tab on UK Version of MVR-300
1.	Dry fit all components to verify that the plastic tabs are too thick for proper flush mounting to wall. If a gap exists between custom cover plate and wall, the plastic tabs are too thick for your back box, therefore proceed to the next step. Otherwise (if no gap exists), no modification is required. Skip this section and use the plastic tabs as is.
2.	<p>Carefully remove plastic tabs from the base plate using nippers, wire snips, or similar.</p> <div style="text-align: center;">  <p>Figure 26. Examples of Tool Needed to Remove Plastic Tabs</p> </div> <hr/> <div style="display: flex; align-items: center;">  <p>DO NOT attempt to “snap” off the plastic tabs. Damage to the base plate may result. Removal of the plastic tabs must be done ONLY with an appropriate cutting tool.</p> </div> <hr/> <div style="text-align: center;">  <p>Figure 27. MVR-300 UK Retrofit of Thinner Metal Mounting Tabs</p> </div>
3.	Attach the metal tabs from the underside of the base plate using the screws provided.
4.	Dry fit the new base plate with metal tabs into the back box, then add the custom cover plate to assure proper fit and to verify flush mounting.
5.	Remove the base unit and prepare for electrical wiring.

10.4 Electrical Installation – UK Version

Wiring installation of the UK version of the MVR-300 includes earth grounding of the custom metal cover plate to the metal back box, and the box to earth ground. Refer to local codes, laws, guidelines, and best practices for wiring instructions. For remaining wiring installation details (power, communications, relays, etc.), refer to Section 3.4 on page 14.

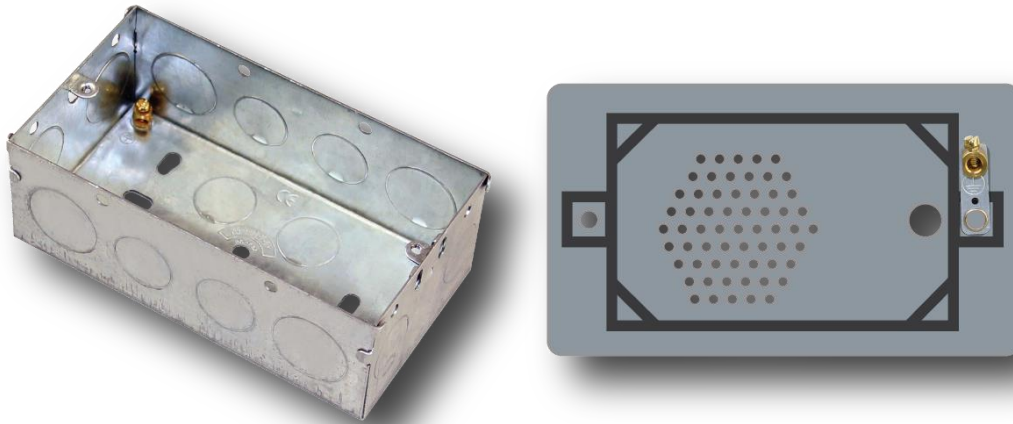

Figure 28. Typical Grounding Lugs on Custom Metal Cover Plate and UK Back Box

10.5 Customizing Face Plates

The UK version of the MVR-300 requires a customized faceplate (not supplied by Bacharach) that provides proper access holes for airflow to the sensor module and visual access to the LED indicator at a minimum. Optional holes for the two magnetic contact points will prevent the need to remove the faceplate for local programming and operation of the MVR-300, but are not required.



NOTICE

If the drill pattern of the customized (metal) faceplate does not accommodate the two magnetic switch locations, the faceplate must be removed to use the magnetic wand functions (e.g., zero adjustment, span adjustment, alarm latching, alarm silencing, etc.).

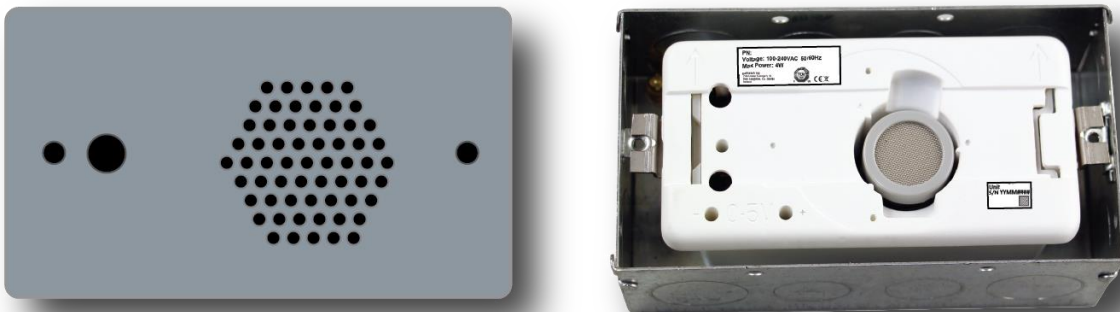

Figure 29. Sample Customized Faceplate with LED and Sensor Cutouts



NOTICE

For specifications and recommended drill patterns for customizing a UK faceplate that properly aligns with the MVR-300 UK, visit the MVR-300 product page at www.mybacharach.com or contact Bacharach.

10.6 Calibration

Use the custom UK version of the calibration adapter to calibrate (zero or span) the UK version of the MVR-300. The UK version of the calibration adapter is a rubber boot that fits down over the Sensor Module. Unlike the standard Calibration Adapter, the UK Calibration Adapter has three vertical slits to accommodate the sensor module alignment ribs as the adapter is fitted down onto the Sensor Module.



Figure 30. UK Version Calibration Adapter with Tubing

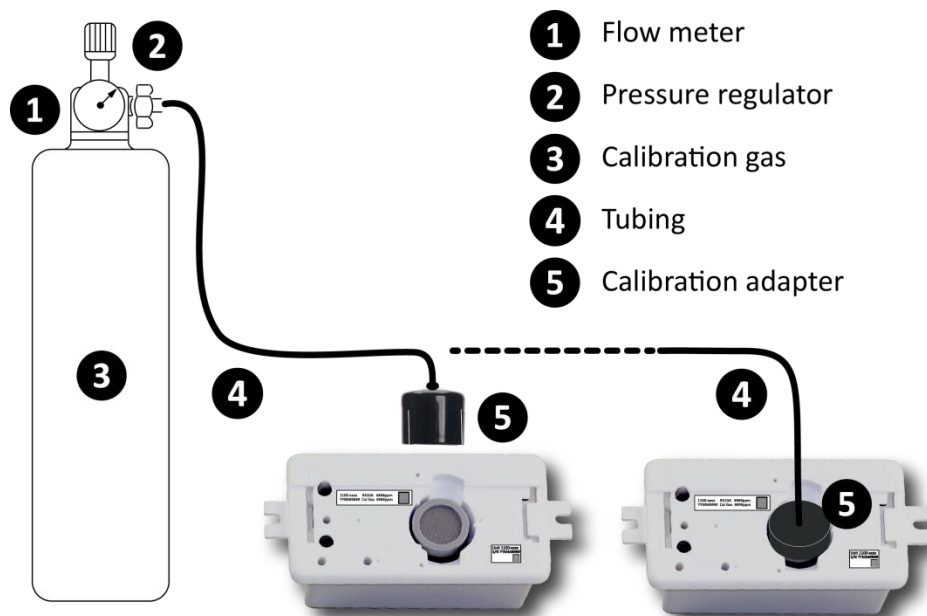

Figure 31. MVR-300 UK Calibration Components

Item	Description of MVR-300 UK Calibration Components
1	Flow meter
2	Pressure regulator
3	Calibration gas
4	Tubing
5	Calibration Adapter (UK version)



NOTICE

Though calibration of the standard MVR-300 can be done from the faceplate or the base plate (with the bezel and faceplate removed), calibration of the *UK version* is designed to be done using the rubber calibration adapter with the custom faceplate removed.

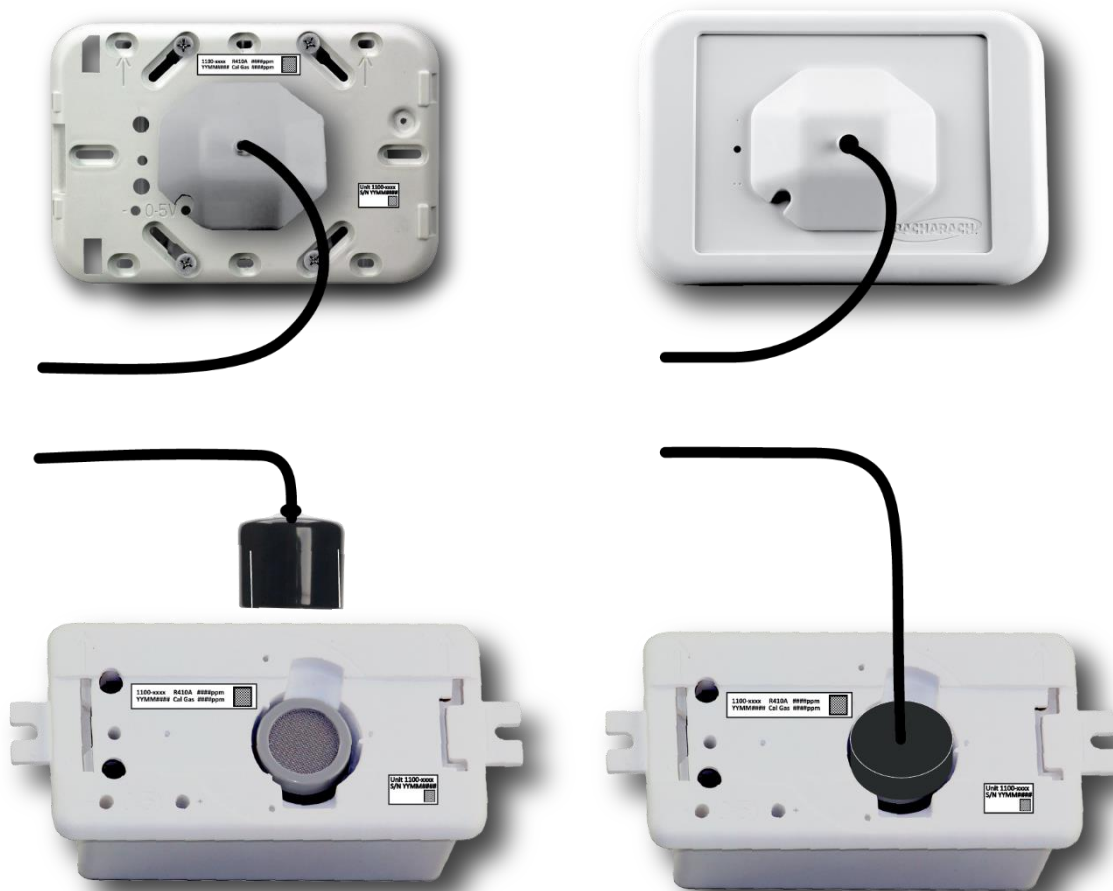

Figure 32. Standard (Top) vs. UK Version (Bottom) Calibration Adapters with Tubing



NOTICE

Aside from the calibration adapter itself (and the fitting of the adapter to the MVR-300), the actual zero and span calibration process is the same for both the standard and UK versions of the MVR-300.



World Headquarters

621 Hunt Valley Circle, New Kensington, Pennsylvania 15068

Phone: 724-334-5000 • Toll Free: 1-800-736-4666 • Fax: 724-334-5001

Website: www.mybacharach.com • E-mail: help@mybacharach.com